

Safety is an indispensable factor when you are considering climate control for your rooms. Whether you are looking for air-conditioning in offices or banks, climate control in sensitive hospital wards, a process climate for IT and production areas or to meet cleanroom requirements. TOUFAN TAHVIEH Air conditioners provide the Perfect solution for all tasks. TOUFAN TAHVIEH is a 10-year old well established company in IRAN with production facility in KARAJ-IRAN, employing over 100 people. The staff of IRAN factory applies innovative approaches and tried-and tested expertise to provide customer needs solutions in line with the constantly increasing demands of the market place. We bring to fruition special projects and meet bespoke requirements, proof of our flexibility. Well thought out, all embracing solutions, from the original idea to advice, planning, development and production, right through to assembly and maintenance. Modern, state of-the-art production plants and consistently applied quality management under DIN EN ISO 9001:2000 guarantee a recognized quality standard for our products. "Just-in-time" delivery included.

Contents

Title	Page
Introduction	4
Nomenclatur.....	7
Feature and benefits Unit	8
HVAC Design Fundamental.....	14
Application Considerations.....	17
Components and Option	19
Hygienic Units	26
Working Rang	27
Description of the Series.....	29
Quick Selection Tip	29
Air Handling unit selection	30
Dimension and Weights	34
Mechanical Specification	35

Introduction

Performance Climate Changer air handlers combine the **TOUFAN TAHVIEH** tradition of engineering excellence with the latest in manufacturing technology to give you an energy efficient air handler with superior performance, the highest quality and reliability, and the lowest installed cost in the industry. This air handler was designed to incorporate such features as component flexibility, integrated control options, and proven performance to give you the optimal system to clean, filter, dehumidify, heat, and cool your building.



Superior Performance

- ASHRAE 111 Class 6 low-leak casing design achieving less than 1.0 percent leakage rate at +/- 8 inches w.g.
- Less than L/240 @ +/- 8 inches w.g. panel and door deflection
- 2-inch Polyurethane foam-insulated, mid-span thermal break panels and thermal break doors Casing thermal resistance ratio TR-value of 0.6
- New filter technology that exceeds LEED (Leadership in Energy and Environmental Design) requirements and reduces filter pressure drops.

Industry-Leading Energy Efficiency

- Discharge plenums and plenum fan sections available with variable size, type, and location of openings to reduce static pressure loss and lower energy consumption
- 50,000 hour LED service lights
- Low-leak, high thermal performance casing design
- All airfoil-bladed dampers and Special dampers meet ASHRAE 90.1 lowest specified leakage requirements
- High-efficiency coil fins deliver superior heat transfer while allowing face velocities in excess of 625 fpm without moisture carryover

TOUFAN TAHVIEH Air Handling Units are fabricated from penta post heavy gauge hot dip galvanized steel profiles and PE corner connection. Panels and frame are secured using internally bolted fixings. The Gasket liner between the panels and frame ensures an excellent leak tight and also works as thermal and acoustic insulation and guarantees the tightness of the casing according to DIN EN1886.

System Optimization

- Factory-engineered, mounted, and tested control packages with properly sealed casing openings.
- Variety of coil types with high-efficiency coil fins allow lower coil approach temperature and reduce chance of moisture

carryover

- Ability to choose the exact number of fins per foot of coil surface to enhance heat transfer and air pressure performance
- Wide array of fan options, including direct-drive plenum fans, belt-drive plenum fans, and housed fans
- Control options to easily incorporate fan pressurization and demand control ventilation strategies.
- Design and analysis tools provide whole building analysis, acoustical design guidance, equipment performance data, and suggested control strategies to help achieve optimum system design with tailored energy, IAQ, and project budget solutions.
- All fans are dynamically balanced in the horizontal and vertical planes.
- Integrated raceway for wiring protection

Wide Range of Sizes

Various sizes of optimally engineered Air Handling Units can be supplied by TOUFAN TAHVIEH to handle air volumes from: 1000 m³/h to 85000 m³/h

TOUFAN TAHVIEH Air Handling Units provide you the best overall total value based upon life-expectancy, functionality, energy efficiency and serviceability.

TOUFAN TAHVIEH custom products and system designs incorporate many engineering and performance features that maximize equipment up-time and the additional benefit of reduced equipment energy and maintenance costs.

Lowest Installed Cost

- Lifting lugs included on the integral base frame
- Indoor units ship with skid designed for forklift transport
- Variable height, size, type, and location of openings on discharge plenums minimize duct transitions
- Factory-installed interoperable controls shorten construction cycles, simplify job-site coordination, reduce installation time and expense, and provide single-source responsibility for warranty and service issues
- Quick-connect wiring minimizes installation costs and provides wiring integrity between sections
- Factory-installed conduit connectors eliminate penetrations in the wrong location
- Motor leads can be run through flexible metal conduits to external motor junction box
- Duct supports designed into factory roof curbs for pre-connection of ductwork For dimensional information on Performance Climate Changer air handlers see

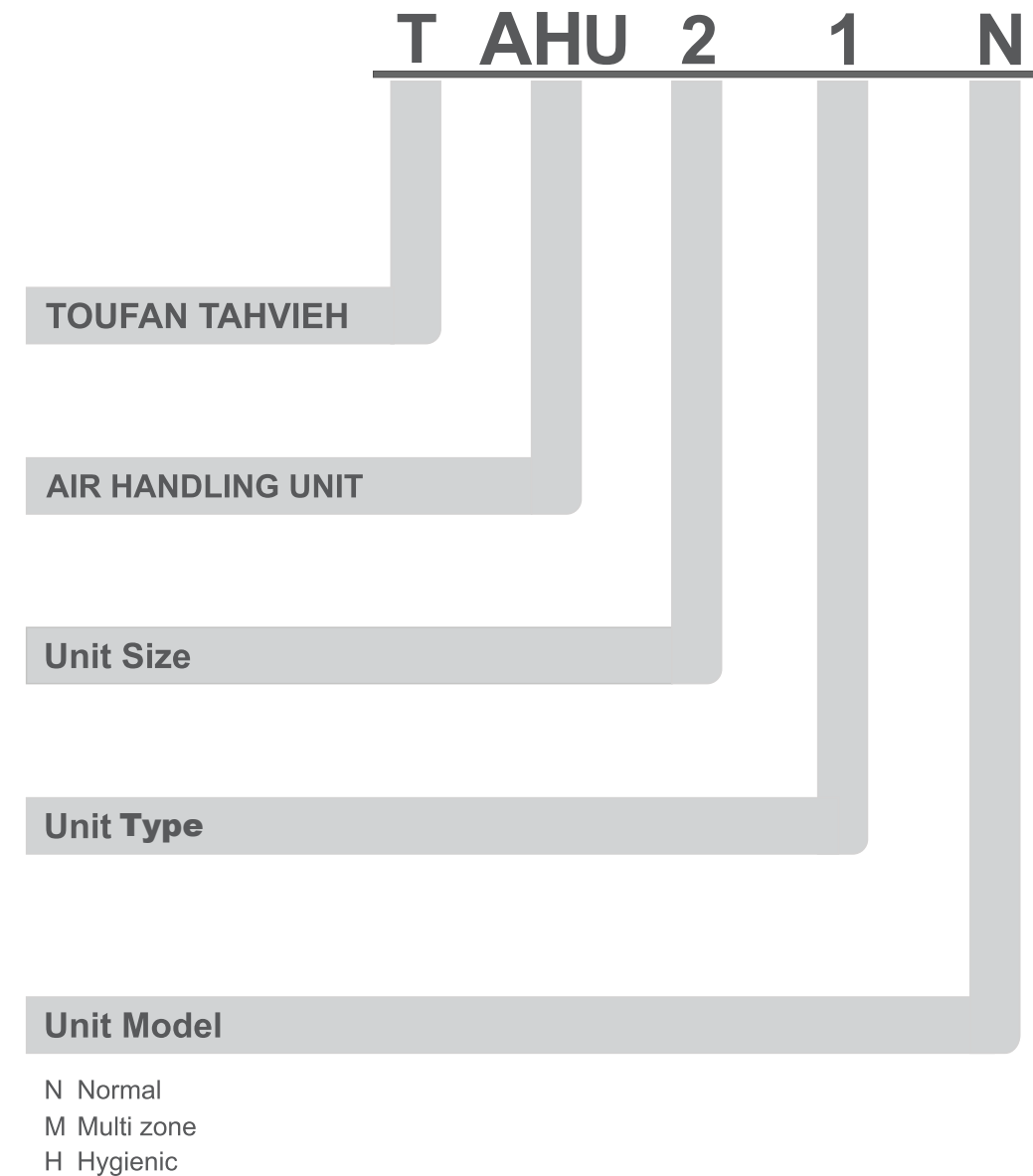

Features and Benefits – Unit

For, Function and Flexibility

Flexibility and versatility are standard in the Performance air handler. As a customizable cataloged air handler, standard components can be arranged to meet most commercial, institutional and industrial applications for the indoor air handler market. Pre-engineered custom options expand that flexibility while ensuring proven, tested performance and dependability, and reducing the costs and long lead times associated with most custom units. Some projects call for an air handler that incorporates new, emerging technologies or a job-specific requirement. TOUFAN TAHVIEH's experienced team of professionals can tailor the Performance air handler to meet these requirements.

The Performance air handler design adopts a "building-block" approach that allows you to design a unit specifically for your project. Choose the "blocks" you need from the wide range of standard and custom-engineered sections, and arrange them to satisfy the air-handling requirements of the application.

Reduces Footprint when Stacked

The Performance unit's design makes it easy to stack sections - even coil sections. Reducing the unit footprint is very advantageous, especially in tight mechanical rooms or limited roof space. The structural

integrity remains intact, even when panels are removed for service or maintenance activities.

Eases Retrofit, Renovation, and Replacement

Buildings age, usage changes, loads change, new technology emerges, codes and standards are revised. Change is inevitable. The Performance air handler readily lends itself to the special needs of the renovation, retrofit, and replacement markets. The Performance air handler can be shipped in small segments that can easily be moved into tight spaces of existing buildings.

Airside Options

- Many standard options are available for specific applications, including:
- Exhaust or return fan economizers
- Direct space pressurization control
- Thermal break double-wall access doors
- Thermal break casing
- Factory-mounted and run-tested controls
- Versatile access section lengths to meet specific needs
- Multiple belt drives
- Full array of pre- and final filter sections
- LED service lights
- Variable sizes, types and opening locations for discharge plenums, plenum fans, and mixing boxes
- Variable height vertical discharge plenums

- Variable length horizontal discharge plenums
- Positional controls section
- Multiple base frame heights/multiple curb heights
- Single-handle, multiple latch doors
- External motor junction box
- Low-flow Special dampers
- Silencers
- Gas heat
- Flush-mounted dial-type filter gauge
- Stainless steel inner liners
- Tread plate floor

Engineered for Good IAQ

The building industry is continuously evolving and the rate of change is accelerating. The Performance air handler is engineered to address today's multifaceted design issues required to provide good indoor air quality (IAQ). Building owners must give particular attention to maintaining and documenting IAQ to ensure occupant comfort and to meet industry and government regulatory standards.

In Standard 62.1, the American Society of Heating, Refrigerating, and Air Conditioning Engineers (ASHRAE) provides guidance regarding suitable outside air volume to be brought into the building, recommended air filtration, and design recommendations and procedures to control microbial growth. However, applying these principles may lead to greater energy consumption, larger and

noisier units, and increased risk of coil freeze-up. The flexibility of the Performance air handler enables you to configure a unique, IAQ-ready air-handling system that can address all of these concerns.

Serviceability / Cleanability

- Full-size access doors and access sections are available for easy cleaning of internal components
- Fully removable coil and access panels Smooth, cleanable interior double-wall surfaces help improve indoor air quality.
- Coils are raised up out of the drain pan to make all coils removable from the side and provide easier access to the drain pan for cleaning.
- Optional antimicrobial treatments for drain pans and filters.
- Optional Corrosion free, salt water resistant aluminum profil

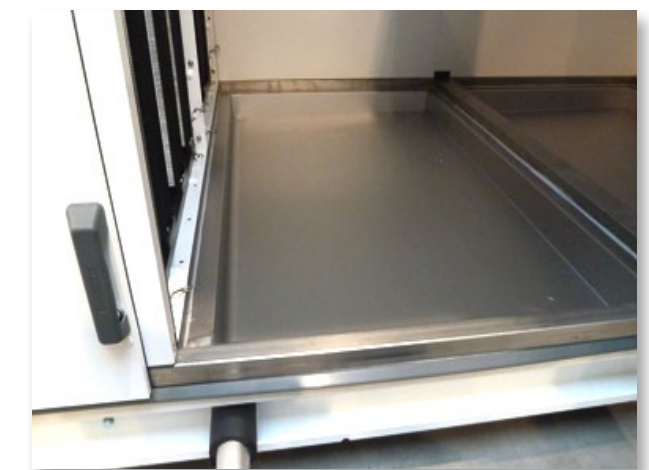

Smooth, interior surfaces make cleaning easy

Sound-Sensitive Solutions

Acceptable space sound levels enhance occupant comfort and productivity. However, system designs that promote good IAQ can adversely affect acoustics: unlined ductwork, air handlers with solid double-wall construction, and increased fan static pressures (resulting from the addition of energy recovery and increased filtration) can magnify the building's background noise.

TOUFAN TAHVIEH air handlers have unique product flexibility that allow designers to use them in many low-NC (noise criteria) applications. NC curves define not-to-exceed limits for a noise source to achieve a level of occupant acceptance. (See applications engineering manual FND-AM-5, "Acoustics in Air Conditioning," for more information about NC levels.) Performance air handlers can be used successfully in NC 35 offices and schools.



Low noise criterion (NC) applications

Minimize Sound Source

TOUFAN TAHVIEH air handlers have many features to optimize the source sound level for job requirements while minimizing the cost of the air handler including:

A variety of fan types to minimize the sound generated by the fan and to optimize cost no matter the application.

Double-wall perforated insulation helps attenuate high-frequency noise.

Two-inch discharge plenums reduce turbulence and create an end reflection that dampens low-frequency sound. The 2-inch perforated liner option attenuates higher frequency sound.

Turning modules used to turn the air and reduce turbulence work as effective, low-cost silencers.

Silencers for horizontal or vertical discharge in the plenum fan section come in 3-ft. and 5-ft lengths.

They are dissipative or film-lined for hospital and cleanroom applications.



Plenum fans help reduce noise levels

Increase Operating Efficiency

The TOUFAN TAHVIEH system is a design philosophy that uses low flow rate and low temperature on both the waterside and airside, along with high-efficiency equipment.

Along with reducing emissions, it also reduces first cost, lowers operating costs, and improves the acoustical characteristics and comfort of the HVAC system. Low-temperature, low-flow systems can challenge conventional cataloged air-handling units. The flexibility of the Performance air handler makes it ideally suited for low temperature applications.

In addition:

- TOUFAN TAHVIEH has developed a unique high-efficiency fin surface that allows face velocities in excess of 625 fpm without moisture carryover. The fins have been engineered and tested to meet these higher face velocities at a given set of design conditions. This allows you to utilize the latest in airside heat transfer to further improve the efficiency of the overall system by lowering the coil approach temperature.
- The ability to choose the exact number of fins per foot of coil surface allows heat transfer and air pressure drop performance to be tuned to specifically meet project needs.
- The wide array of fan options lets you choose the right fan for the application.
- Factory-engineered, tested controls provide the added insurance that the airflow sensors and sequences meet your requirements.

- Further system enhancements can be made by taking advantage of the latest controls technology with fan pressurization control (required in most variable-air-volume systems per ASHRAE Standard 90.1) and/or ventilation reset of the outside air damper based upon occupancy levels in the space.

NOTE:.....

.....

HVAC Design Fundamentals

In essence, an air-handling unit, or AHU, is exactly what its name implies: a device that “handles” (moves and/or conditions) air. It accomplishes this based on the functions required by a given application, as well as the arrangement of components necessary for those functions. TOUFAN TAHVIEH air handlers can accommodate an extraordinary degree of design versatility, but in order to apply that versatility to each unique application, an HVAC designer must:

- Design the air handler in a manner consistent with good HVAC design practices.
- Understand the impact of ASHRAE Standard 62.1, Ventilation for Acceptable Indoor Air Quality, and ASHRAE Standard 90.1, Energy Standard for Buildings except Low-Rise Residential Buildings, on AHU functions and design.
- Know how specific components can address application requirements, with arrangements optimized for job requirements, thermal performance, and acoustical performance.
- Deliver the performance you have designed with a well-functioning control system.

Provide Proper Ventilation

Ventilation is the process of diluting the build-up of contaminants by introducing clean, fresh outdoor air into buildings. The lack of

proper ventilation is identified as a leading cause of poor indoor air quality (IAQ) problems. ASHRAE Standard 62.1 sets the minimum ventilation rates and specifies basic HVAC equipment and system requirements to provide “acceptable indoor air quality.” ASHRAE Standard 62.1 is considered the standard of care for designers to assure good IAQ in commercial buildings.

Assuring proper ventilation levels at all operating conditions can be challenging for a designer. Fixed outdoor-air damper arrangements on variable-air-volume systems can result in severe under ventilation of the occupied spaces at part-load conditions. The Performance air handler is available with the patented Special outdoor airflow measurement and control damper, which can precisely control the volume of ventilation air entering the system and even dynamically vary the amount in response to specific operating conditions. With the Special damper, the amount of outdoor air can be continuously logged using a Tracer Summit™ building automation system to document proper ventilation.

Maintain Building Pressure

An important aspect of establishing outdoor-air requirements is equalizing outdoor-air and exhaust-air volumes to maintain proper building pressurization. Building pressurization describes an air-handling strategy that regulates pressure differences across the building envelope and between zones or rooms by adjusting the amount of air that is supplied

and removed. The goals of this strategy are to:

- Assure proper distribution of conditioned and ventilation air throughout the occupied space
- Avoid discomfort due to temperature stratification and drafts
- Prevent infiltration of unconditioned air
- Confine odors and contaminants to specific areas within the building

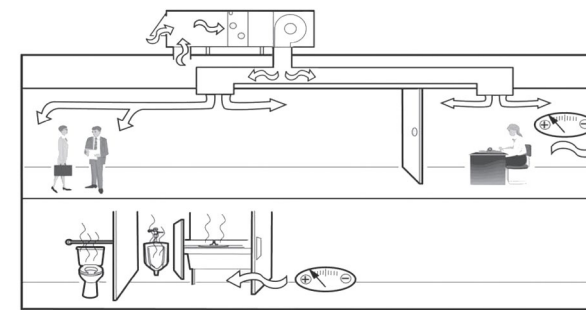

Maintain proper building pressurization

Building-envelope pressurization is typically achieved by incorporating either an exhaust fan and economizer or a return fan and economizer in the air handler design. Careful analysis is required to determine which approach best suits the unique requirements of each application. To better understand the differences between exhaust-fan and return-fan systems, consult your local TOUFAN TAHVIEH sales representative or refer to applications engineering manual, Building Pressurization Control

Filter Contaminants

Particulate Filter Guidelines

The Environmental Protection Agency (EPA)

and ASHRAE recommend that the concentration of particulates in the air not exceed 0.05 mg/m³ (measured as an annual mean). This guideline is established in an EPA PM-10 standard which focuses on smaller particulates (<10 microns) that are likely responsible for adverse health effects because of their ability to reach the lower regions of the respiratory tract. ASHRAE Standard 62.1 and the U.S. Green Building Council LEED rating system emphasize the importance of including appropriate filters in the air handling system to effectively control particulate contaminants. Both establish minimum requirements for filter performance applied within a commercial building based on ASHRAE Standard 52.2, Method of Testing General Ventilation Air-Cleaning Devices for Removal Efficiency by Particle Size. This standard establishes a test procedure for evaluating the performance of air-cleaning devices as a function of particle size (0.3 to 10 microns). A minimum efficiency reporting value (MERV) is assigned to a filter based on its efficiency in three different particle-size ranges (0.3 to 1 microns, 1 to 3 microns, and 3 to 10 microns). A higher MERV rating indicates a greater ability to remove high quantities of small particles from air.

ASHRAE Standard 62.1 recommends a minimum MERV 6 filter, while the USGBC LEED rating system recommends a minimum MERV 8 during the construction cycle and MERV 13 during normal operation. National, state, or local codes established by

government bodies or occupational groups may dictate more specific or stringent filtration requirements. A wide variety of filter types is available to meet any filtration requirements, including flat filters, low-velocity filters, bag filters, HEPA filters, carbon filters, and other types.

Options:

- Carbon active filters
- Stainless steel filter frames.
- Differential pressure switch
- Sand Inertia filters
- For visual indication of the filter conditions, an inclined manometer for indoor applications can be provided or alternatively, special manometer can be provided specially for the outdoor applications.

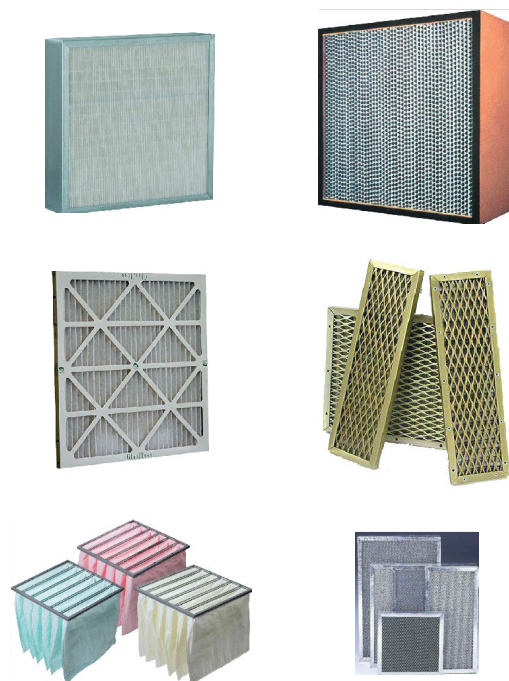

Minimize Microbial Growth

Although filtration effectively removes a number of common particulate and gaseous contaminants from the building environment, microbiological, or microbial, contaminants such as fungi (mold and mildew) and bacteria are sometimes too small to be filtered entirely from the air stream. To help control microbial growth, design the air handler to include:

- Non-porous, cleanable interior wet surfaces
- Easy access to all areas of the air handler for inspection, service, and cleaning.
- Use of ultraviolet (UV) germicidal irradiation lights

Regular cleaning and disinfecting with nonpolluting cleansers and antimicrobial coatings also helps, but none of these measures totally eliminates the growth of ever-present microorganisms. Consequently, moisture control becomes another important means of combating microbial contaminants.

Water Management

Cooling coils collect water from the passing air stream as they cool and dehumidify it. If not properly addressed, this condensed moisture encourages mold, mildew, and other microorganisms to colonize and breed. To reduce the likelihood of microbial growth:

- Reduce moisture carryover by sizing the cooling coils for proper airflow velocities. TOUFAN TAHVIEH coils can be sized for

velocities in excess of 625 fpm without moisture carryover, depending on air conditions, coil size, and coil-fin type and spacing.

- Specify drain pans sloped in two planes to eliminate stagnant water conditions and to promote positive drainage.
- Locate coils on the second level of a stacked air handler to provide adequate trapping height.
- Properly size condensate traps to ensure proper drainage.
- Promote cleanability by providing adequate space around the unit, easily removable access panels, and a solid steel liner to isolate insulation from the air stream and to facilitate cleaning. Also, provide extended drain pans to allow for periodic cleaning.
- Condition the mechanical equipment room to prevent condensation on piping, ductwork, mechanical equipment, and other surfaces.

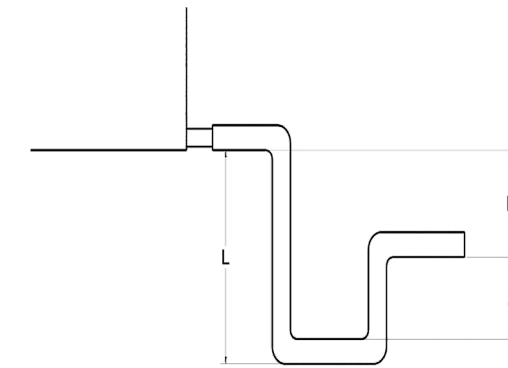

Drain pan trapping for positive and negative pressure applications

Drain pan trapping for section Under negative pressure	Drain pan trapping for section under positive pressure
$L = H + J + \text{pipe diameter where:}$ $H = 1 \text{ inch for each inch of negative}$ Pressure plus 1 inch	$L = H + J + \text{pipe diameter where:}$ $H = \frac{1}{2} \text{ inch (minimum)}$ $J = \frac{1}{2} \text{ inch plus the unit positive static}$ pressure at coil discharge (loaded filters)
$J = \frac{1}{2} H$	

Dehumidification

ASHRAE Standard 62.1 observes that “high humidities can support the growth of pathogenic or allergenic organisms” and suggests that the relative humidity of the occupied space not exceed 60 percent. Higher humidities also require lower supply-air temperatures for thermal comfort.

Most climates require dehumidification to achieve this design goal. Dehumidification can be accomplished by removing moisture from the air that is, condensing the water vapor on cooling coils.

However, cooling coils can over cool the occupied space when dehumidifying at sensible part load conditions. There are several ways to

control to both humidity and temperature at part load conditions.

- Use a VAV air handler versus a constant volume air handler. This can improve part load dehumidification.
- Use desiccant dehumidification systems to dehumidify and control humidity to very tight tolerances.
- Use a split dehumidification unit (SDU) to improve dehumidification by treating the ventilation air separately.
- Use as Dedicated Outside Air Unit, DOAS, to dehumidify the ventilation air.
- Use a reheat coil, which can be accomplished using recovered condenser heat energy or with standard electric or hot water coils.

Humidification

Low relative humidity - below 30 percent - in an occupied space is also undesirable because it requires higher supply-air temperatures for thermal comfort and promotes static electricity.

Raising the space humidity to an appropriate level requires a humidifier to inject water particles into the passing air stream. To avoid promoting microbial growth, the unit design must assure that the injected water is fully absorbed within the air handler without collecting on its walls or components.

Three types of commercial humidifiers are generally used in central-station air-handling systems: wetted media, atomized water, and steam. Of these types, ASHRAE Standard

62.1 prefers steam “as the moisture source for humidifiers.” The temperature and pressure properties of steam make it easy to introduce directly into the passing air stream and encourage complete absorption in a short distance. TOUFAN TAHVIEH standard humidifier sections incorporate all the distance required for absorption to occur.

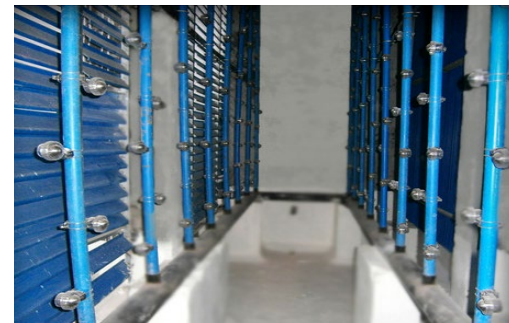

Application Considerations

- Never position the humidification section immediately downstream of a housed fan or blow thru
- Coil section.
- Extra dispersion distance may be needed if the humidification section is placed upstream of a final filter or electric heat coil.
- Vertical airflow turns immediately upstream and downstream of the humidification section necessitate a large section.

Air Handler Design

Which design best suites the application? After determining the required airflows and functions for a particular application, the HVAC designer must determine which one of two path layouts for outdoor air best serves the application: single-path or dual-path.

Single-Path Design

Single-path AHUs rely on one outdoor air path. Depending on application requirements, that path may provide ventilation air only or both ventilation air and economizing air for natural, non-mechanical cooling. Components for filtering and tempering the air are arranged in series. The single path layout can accommodate passive or powered return- and/or exhaust-air paths as well as

energy recovery.

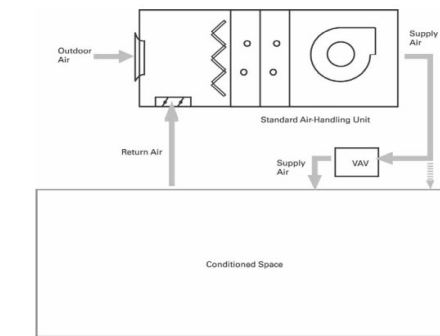

Single-path design

Dual-Path Design

Dual-path AHU layouts provide two air paths. Like a single-path design, dual-path designs can incorporate basic outdoor air, recirculation, exhaust-air, and energy-recovery functions. However, one path is dedicated to handling ventilation air to specifically address ASHRAE Standard 62.1 requirements. Each path is provided with its own air treatment components such as filters and heating and cooling coils.

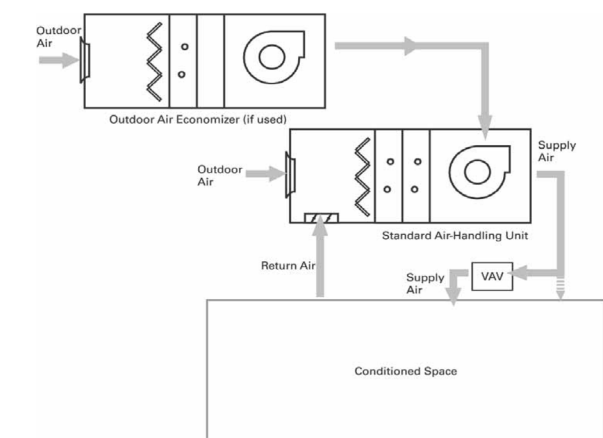

Dual-path design

Application considerations:

- Reduces or eliminates reheat requirements, while providing an effective means of dehumidification for loads with low sensible-heat ratios (high latent cooling requirements)
- Avoids increasing supply-fan static pressure due to high pressure drop components in the ventilation air stream (increases latent cooling and filtration capacity without increasing fan size)
- Permits downsizing of the ventilation-path components
- Enables compliance with the ASHRAE Standard 62.1 requirement for measuring outdoor airflow without significantly increasing the first cost of the air handler
- Provides a cost-effective means to increase ventilation airflow in an existing system
- Reduces cost by reducing the number of units (dedicated outdoor-air units can be eliminated).

Standard AHU Arrangements

To complete the air-handling system, the sections must be physically arranged in a way that fits the available space. Conventional descriptions of air handler arrangements draw-thru and blow-thru reflect the means of establishing airflow through the coil based on the position of the coil relative to the fan: the fan either draws air through a coil located upstream or blows air through a downstream coil. TOUFAN TAHVIEH adds another

dimension to air handler arrangements, letting you combine sections by stacking them on top of each other in space-saving configurations, by coupling them together with transition panels, or by combining both techniques. Careful evaluation of the merits of each arrangement is a critical part of the design process.

Draw-Thru Arrangements

A draw-thru AHU arrangement places the coils and filters upstream of a ducted supply fan. It can be single- or dual path.

Horizontal Draw-Thru

Accepted system design practices are generally the only restrictions in a horizontal draw-thru application. However, certain application rules must be followed to promote

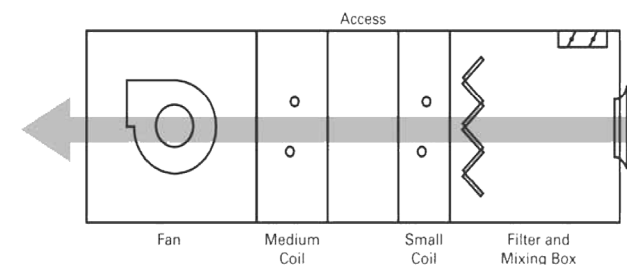

proper airflow through filters and coils.

Vertical Draw-Thru

TOUFAN TAHVIEH air handlers in a vertical draw-thru arrangement typically result in a shorter footprint than horizontal draw-thru

units. This arrangement stacks a fan on top of a vertical coil section. When designing an air handler in this configuration:

- The bottom deck must be equal to or longer than the fan section to avoid creating a “cantilever” effect.
- A vertical draw-thru fan performance curve should be used to account for the

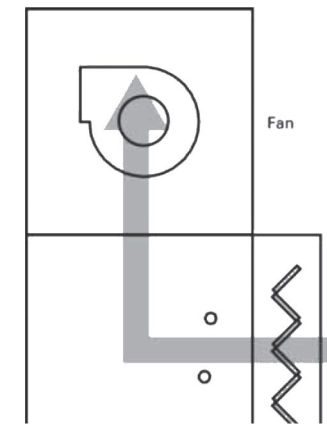

airflow impingement by a coil installed in a vertical coil section.

Components and Options

Coils

The variety of TOUFAN TAHVIEH coil types, sizes, arrangements, and materials allows you to select a coil that is optimized for pressure drop and capacity requirements. Published coil performance is certified in accordance with AHRI Standard 410. Through extensive testing and numerous job-site installations, TOUFAN TAHVIEH has developed unique fin surfaces for its coil

offerings. These enhanced fin surfaces have superior heat transfer characteristics and allow greater velocities of air to move through the cooling coil without causing moisture carryover.

The industry is familiar with the 500-fpm limit through a cooling coil as a “rule of thumb” to safeguard against moisture carryover. However, some applications have tight dimensional constraints that require high coil face velocities. TOUFAN TAHVIEH fin designs extend this limit in excess of 625 fpm, depending upon air conditions, coil size, and coil-fin type, and spacing.

All coils designed to deliver their respective duties at optimum performance at all design conditions and to meet a wide range of applications and requirements. As a standard, coils are manufactured from seamless copper tubes of 1/2” OD, mechanically expanded into collar continuous corrugated aluminum fins to provide a continuous compression bond over the entire finned length for maximum heat transfer rates. The standard fin spacing is 2,1 mm; however 3,2 , 2,5 and 1,8 mm are available as an option upon the client request or to achieve the determined indoor conditions. Extensive cleaning is done after manufacturing each coil for optimum system cleanliness and all coils are factory tested at 450 psig air pressure underwater. Due to the huge variety of coil input conditions, the coils calculation and selection is optimally done based on a fully wetted coil by selection software integrated in the unit selection

software to match the required conditions. Direct expansion coils are equipped with a properly sized expansion valve and distributor to ensure equal refrigerant fed to all circuits. The number of circuits is chosen to provide optimum heat transfer and reasonable refrigerant velocity and pressure drop so as not to trap any oil in the coil tubing. Headers and connections for water coils and DX-coils are made of seamless copper pipes, and inlet and outlet connections are sealed against unit panels by rubber gaskets as standard wherever coil connections protrude through the casing. Utilizing the full available unit cross section area, coils are mounted in the unit casing on noncorrosive slide rails to allow for easy coil slide in – slide out when required. All water coils are fitted with plugged drain and vent tapping to facilitate draining and venting.

Coil options include but are not limited to the following:

- 304/316L Stainless steel coils casing
- copper fins coil
- Pre-coated fins coil epoxy
- 5/8" tube diameter - coils
- Coated coils: Heresite, Bly-Gold or thermo guard
- Variable fin spacing on all fin types to fine-tune coil capacity and air-pressure drop

Drain Pans

In order to remove the condensate, dropped-out during dehumidification, the drain pan is

supplied under the cooling coil, cover the entire coil section. The drain pan, as standard, is made from stainless steel, material code 304L. For best drainage, drain connection given from one side of AHU (left or right). For AHU's drainage connection, due to the big size of coils could be provided from both sides. The drain pan outer surface is insulated by (1/8"-thick) closed cell foam insulation to prevent condensation.

Options:

- ▶ Intermediate drain pan for small Units
- ▶ 316L Stainless steel pain

Fans

An extensive array of fan types and options, including variable-frequency drives (VFDs) for modulation in variable-air-volume systems, lets you optimize the fan to best fit not only the airflow and static pressure requirements, but also the acoustical, efficiency, and discharge requirements.

Each fan is rated in accordance with Standard 430 of the Air Conditioning Heating and Refrigeration Institute (AHRI) and all DWDI fans are AHRI Standard 430certified to assure Published performance.

1- Centrifugal Fans

The standard used fans are high performance Double Width Double Inlet (DWDI) centrifugal fans, optimally engineered for HVAC application, with high quality, and fully

tested performance in accordance with DIN 24166 accuracy class 1, ISO 5801 BS 848-Part1 and AMCA 210 standards. All fans are optimally selected for best performance and sound characteristics based on maximum fan efficiency.

The impellers can have forward curved , backward inclined or airfoil profile blades depending on the customer requirement and the system static pressure. The impeller is galvanized finished for forward curve blade; glass reinforced polyamide or welded heavy gauge steel painted with epoxy for backward and airfoil blade. All fans are statically and dynamically balanced for stable non surging operation.



2- Plug Fans

Most of the energy consumed by an air handling unit is the electricity used to run the fan motor, whilst only a small percentage of the energy goes to heat generation, so high fan efficiency means power saving, this is why the plug fans which are high fan efficiency significantly reduces the consumption of electricity, and therefore the operation cost. Direct Drive simplicity converts to less operating expenses also as there are no fan shafts, bearing, belts or guards to maintain. Noise emission level of air handling units is also one of the most important environmental factors which we fine-tuned our product to reduce it, the choice of using plug fan will be ideal to achieve this goal. Plug fans are extremely quiet Efficiency and quiet operation make an exceptional combination for your air handling unit.

Blower Motors

Fan motors are totally enclosed, fan cooled (TEFC) squirrel cage type with class "F" insulation at 40 °C ambient temperature and continuous duty. Motors are of IP55 and protect the motor from dust and water; it is mounted on an adjustable slide so that the belt tension can be easily adjusted. With a voltage tolerance ±10% and frequency tolerance ±5%, motor can operate in an ambient -16 to +40°C according to IEC60034-1 standard. For motor sizing the mechanical

losses incurred in transmitting the load from motor shaft to the fan shaft are taken into consideration along with a reasonable safety factor.

Options:

- Explosion Proof motors
- Two speed motors
- Stand by motors
- VFD for motor

Standard motors are fitted with six terminals, and a terminal connection and wiring diagrams are shown in the motor terminal box.

Drives

Transmission of power from the motor to the fan is provided by means of a set of pulleys and matching V-belts. The pulleys are taper-locked to the fan and motor shaft. TW-series air handling units are equipped with the optimized pulleys and belts, which are sized and pre-installed by factory. Optimal selection of drives and proper installation will ensure that the fan restart at the required designed speed and at same time help to optimize fan and motor bearing life.

Vibration Eliminator

In order to reduce the transmission of noise and vibration, the complete fan motor sub-base assembly is mounted on set of anti-vi-

bration mounts. As standard fan assembly is a common base frame entirely isolated from the unit by rubber in shear while as standard in units, the frame isolated by 1" deflection open type spring isolators.

Plenum Section

Empty sections can be provided upon request as an access or to facilitate the function of a component in another section or for future use. The standard length of the plenum section is 500 mm, however, custom sizes to suite any requirements can be provided.

Dampers

TOUFAN TAHVIEH Air Handling Units are equipped with heavy duty, multi-blade, and low leakage dampers to modulate and control the air flow. Dampers can be provided with opposed blades or parallel blades. Dampers are prepared for either manual or motorized operation (motor can be provided as an option). As standard, the damper frame is constructed from 1.5 mm galvanized steel, non-welded counter rotating airfoil oppose galvanized steel blades fitted to the case with close gap, shafts made from chrome plated steel, self-lubricating hard nylon shaft bushes and galvanized steel linkage and brackets.

To ensure low leakage, the dampers are equipped with side-edge seals.

The following dampers alternatives can be provided:

- Airtight according EN1751 DIN 1949
- 304L Stainless steel dampers with airfoil blades.
- Gear type dampers with Aluminum airfoil blades. For easy installation, the damper frame is designed and fabricated to serve as a flange for ductwork connection.

The previously mentioned dampers can be used as:

- Full-face air intake dampers
- Bypass dampers
- Fresh, exhaust, and return air dampers for two-way or three-way mixing box
- Economizer control
- Multi-zone application dampers



Sound Attenuators

Sound attenuators can be used where a significant reduction to fan noise is needed. Attenuators can be provided in the supply and/or return air side with different lengths to provide a range of attenuator performances. Sound attenuators casings are produced with G90 galvanized steel sheets formed and lock formed seams with a sealant. The acoustic infill materials are inert, non-flammable, non-hygroscopic, and will not sustain vermin or fungus and odorless, the infill has a glass tissue facing and is contained behind galvanized perforated metal, which prevent infill material damage and fiber erosion up. To reduce the pressure loss and regenerated noise, the splitters are radiuses at both ends.

Drip Eliminators:

To avoid water carry-over in humid areas or when the velocity of air across the cooling coils is high, drip eliminators are provided. As standard the drip eliminators are provided in two cases:

1. When the velocity across the coil is 2.5 m/s or more.
2. When the water content of the air is greater than 10.5 g/kg of dry air.

Other than in these two cases, the drip eliminator is given as an option upon the request of the customer. Drip eliminator blades are PVC-blades encased within a

galvanized steel frame. The blades are designed to completely prevent water carry over with low pressure drop. The drip eliminator is commonly fixed directly to the coil casing, however, separate section for the drip eliminator can be provided upon request.

Diffuser

A diffuser consists of pressure-equalizing baffles that are designed to provide even airflow across components downstream of a fan. The diffuser section is typically used immediately downstream of a centrifugal fan in a blow-thru filter, coil application.



Run Around Coils

It is an air to water heat exchanger system, it is used to recover sensible heat only, it consists of two coils, one located in the exhaust air stream and the other in the supply air stream, both of them are connected with a pump in a closed circuit (pump and piping by others), the heat transfer medium is water. When the cold air passes through

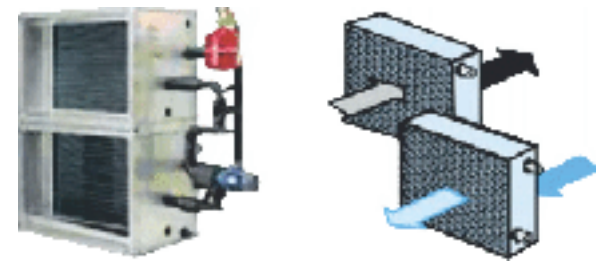

Run Around Coils

the first coil of the run around system which is located in the cold air stream, it cools down the water inside the coil, after the water loses heat, the pump passes this cold water to the coil in the hot air stream, heat exchange happened thus cooling the air and warming the water, warm water returns to the coil in the cold stream and the cycle is repeated.

Humidifier

1. Steam Humidifiers

TOUFAN TAHVIEH Air Handling Units can be equipped with a self-contained humidifier, which is electronically controlled to sense and control the humidity. The steam is generated in a polypropylene cylinder mounted onto the outside of the humidifier section within a special enclosure. A stainless steel distributor suitable in length passes through the unit casing to inject steam in the air stream to reach the needed humidity conditions.

2. Evaporative humidifier/clar

Evaporative Humidifier/Cooler has been specially designed for integration into air-handling systems within both residential

and industrial buildings. The design is compact and sizes conform to all typical air handling units (AHU). The standard product line encompasses a wide range of sizes, options for multi stage control, integrated droplet separators and three nominal humidification efficiencies, 65%, 85% and 95%.

Technology basics

The heart is a cassette made from inorganic noncombustible evaporative media. Water is supplied to the top of the evaporative media via a distribution header. The water flows down the corrugated surface of the media. As warm and dry air passes through the media it evaporates a proportion of the water and thus produces cold, humidified air. The rest of the water assists in washing the media, and is drained back to the tank.

3. Air Washers

TOUFAN TAHVIEH Air Handling Units can be equipped with air washer section which mainly serves for adiabatic cooling, humidifying and air washing. Air washer is a section in which the air flow is brought in contact with a large quantity of sprayed water. Depending on the condition of the circulating water, air washers are forming a basic part of air conditioning plants which easily combine washing, humidifying and cooling of air. While water evaporates on the surfaces of large drops and impurities contained in the air are

washed out, extremely small droplets (Superfine aerosols) can be fully absorbed by the air and they are designed to avoid the formation of superfine aerosols as far as possible.



Application considerations

- Airflow through the humidifier must be horizontal and of relatively uniform velocity (400 to 700 fpm).
- Do not locate the humidifier upstream of filters, gas heat, electric heat, or active cooling coils.
- Blow-thru applications with housed fans require at least a four-row coil between the fan and humidifier modules. The diffuser alone is unacceptable.
- To prevent condensate formation, the relative humidity leaving the humidifier should not exceed 83 percent. Contact your local TOUFAN TAHVIEH sales engineer for application-specific guidance.
- The required dispersion distance is designed into the humidifier section.
- Vertical airflow turning immediately

upstream and downstream of the humidifier section requires a large turning section.

Hygienic Units

TOUFAN TAHVIEH Hygienic Air Handling Units incorporate state-of-the-art technology to provide refrigeration and meet filtration, pressurization, condensation control, and sanitization standards required by the critical applications where ultra clean air needed. The units are custom engineered to produce the specified psychometric conditions and to achieve the environmental design criteria for the area being served.

Taking economic issues taken into consideration, our design engineers can design hygienic air handling units methodically and logically to suit the ultra-clean application requirements. Our Hygienic air handling units comply with the requirements of DIN1946, Part 4, O-Norm H6020, Part 1 and VDI 6022 with following main product features:

- Smooth inside surface design.
- Air tight dampers.
- Light and inspection windows in desired function modules Special joint sealing with silicon-free sealants.

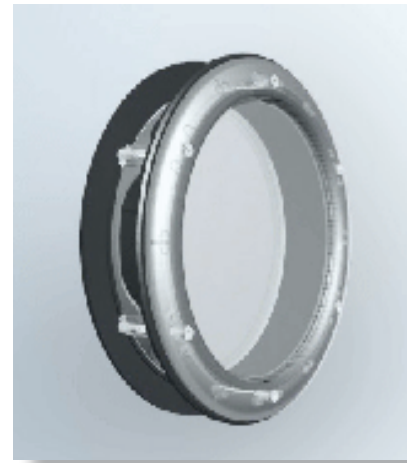

Upon the request the unit can be supplied with additional optional features like:

- Stainless steel panels.
- Condensate nipples in the fan casing.
- Stainless steel fabrication parts for all components.
- Anti-bacterial coating for all the inner casing and components.

TOUFAN TAHVIEH Hygienic Air Handling units are the answer when clean conditioned air is needed for today's hygienic applications, like hospitals, pharmaceutical sectors, food factories requirements, etc

WORKING RANGE

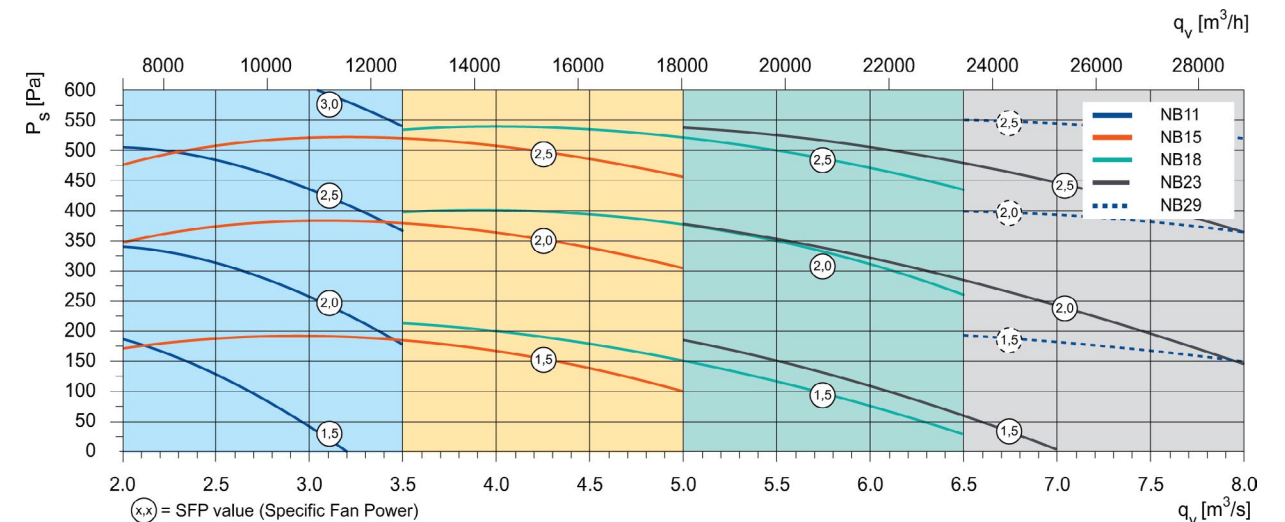
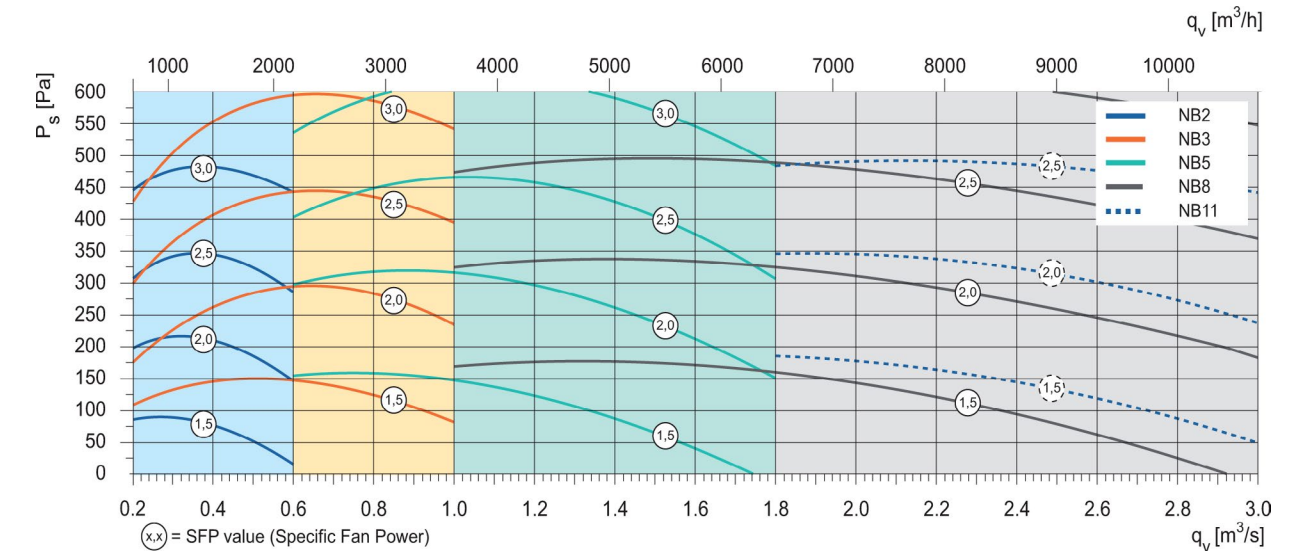

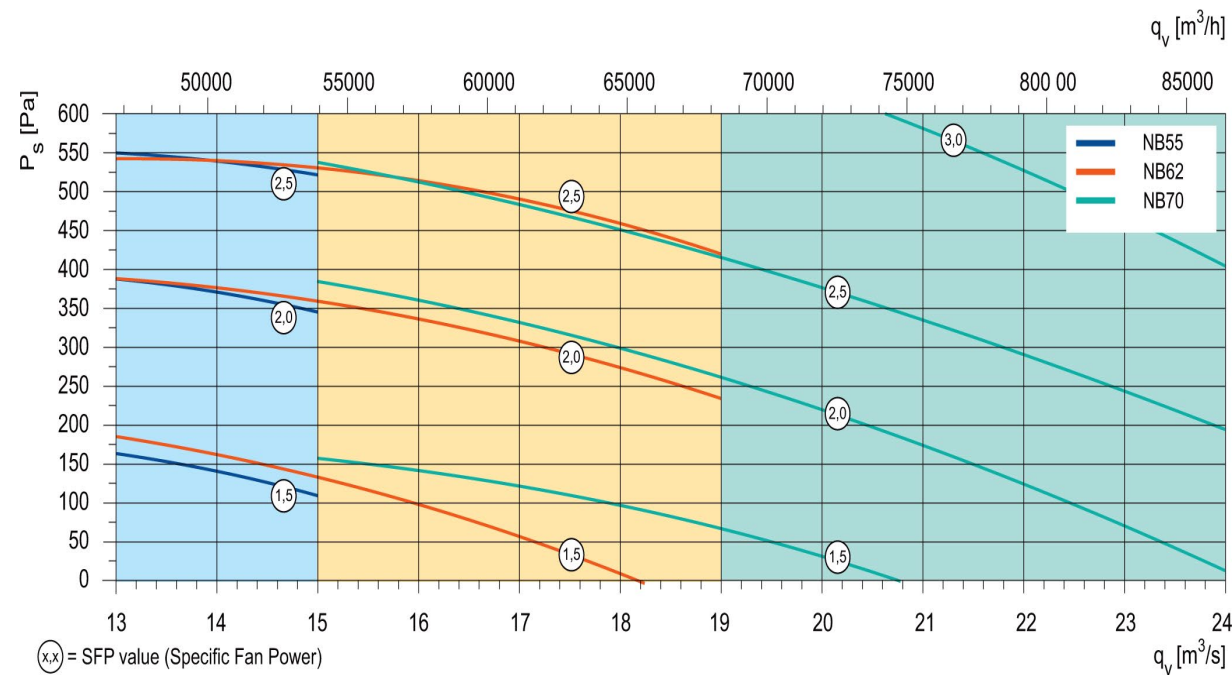
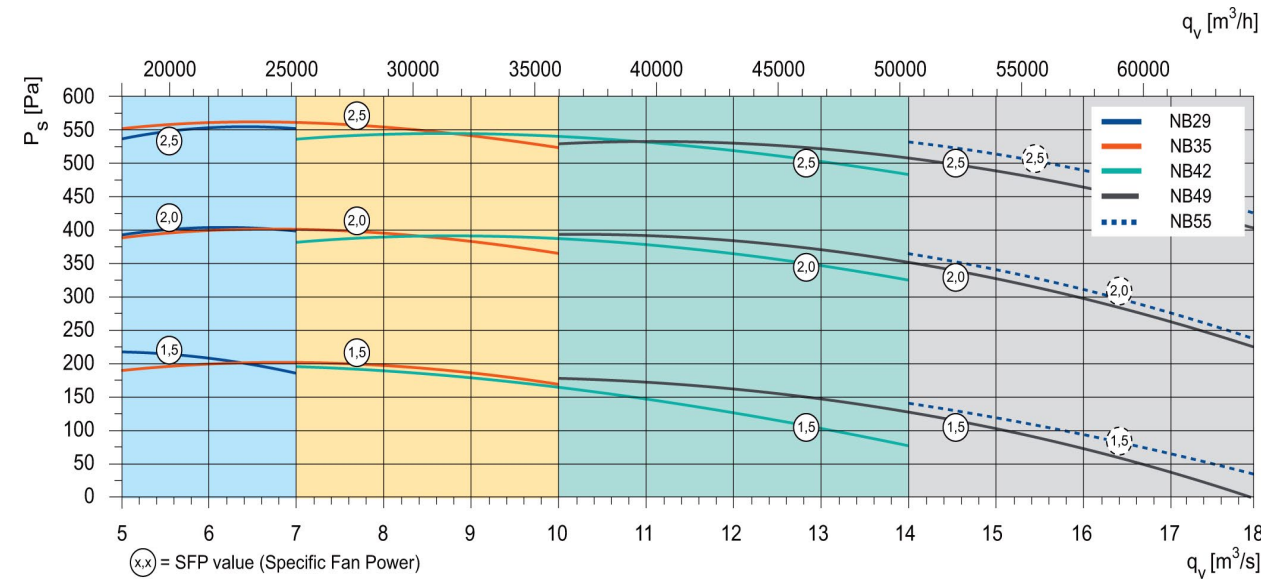

Description of the series

TOUFAN TAHVIEH Air handling Units Range consist of 15 models designated TAHU-2 to TAHU-70 under normal air handling conditions, flow rates between 500 and 67000 m³/h

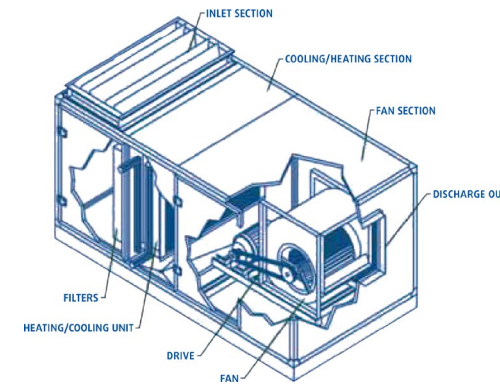

Quick selection tips

IMPORTANT INFORMATION

1. These fast selection criteria are included to help the user choose the equipment for the design specifications.

Nevertheless, this selection method is not precise enough to indicate the equipment that best fits your requirements.

If more precise information is necessary, please talk to our Sales Department.

2. Remember: the following formula must be used to determine the air velocity (m/s):

$$\text{Air velocity} = (\text{Flow rate } m^3/s) / (A \text{ of } m^2 = m/s)$$

3. The data used to determine the number of rows of the units is based on the following values:

Cooling:	inlet air	26,4 C, 4 % RH
	outlet air	13,0 C, 92,0 % RH
Heating:	inlet air	18,0 C
	outlet air	30,0 C

4. The fan features refer to operation in facilities with free inlet and channeled supply outlet, and do not take into account any air flow fittings.

5. The absolute fan power consumption does not include losses attributable to the drive.

A diagram is included so the size of the right air handling unit can be quickly selected for each case.

Based on the air flow rate and air velocity through the heat exchanger units, the diagram indicates the most adequate unit, as well as the relationship with the nearest units in terms of size.

The most common practice is to define the air velocity through a cooling unit at 2.7 m/s, and 3.5 m/s for heating only. These are approximate values only. For further information, refer to the section on heating and cooling units provided below.

Example:

An air handling unit is needed for an air flow of 19200 m³/h: On the selection diagram, start with the scale in m³/h and vertically locate the point where this flow rate has the velocity of 2.7 m/s, in this case the one that corresponds is the TAHU-23 Air Handling Unit.

Air Handling Unit Selection

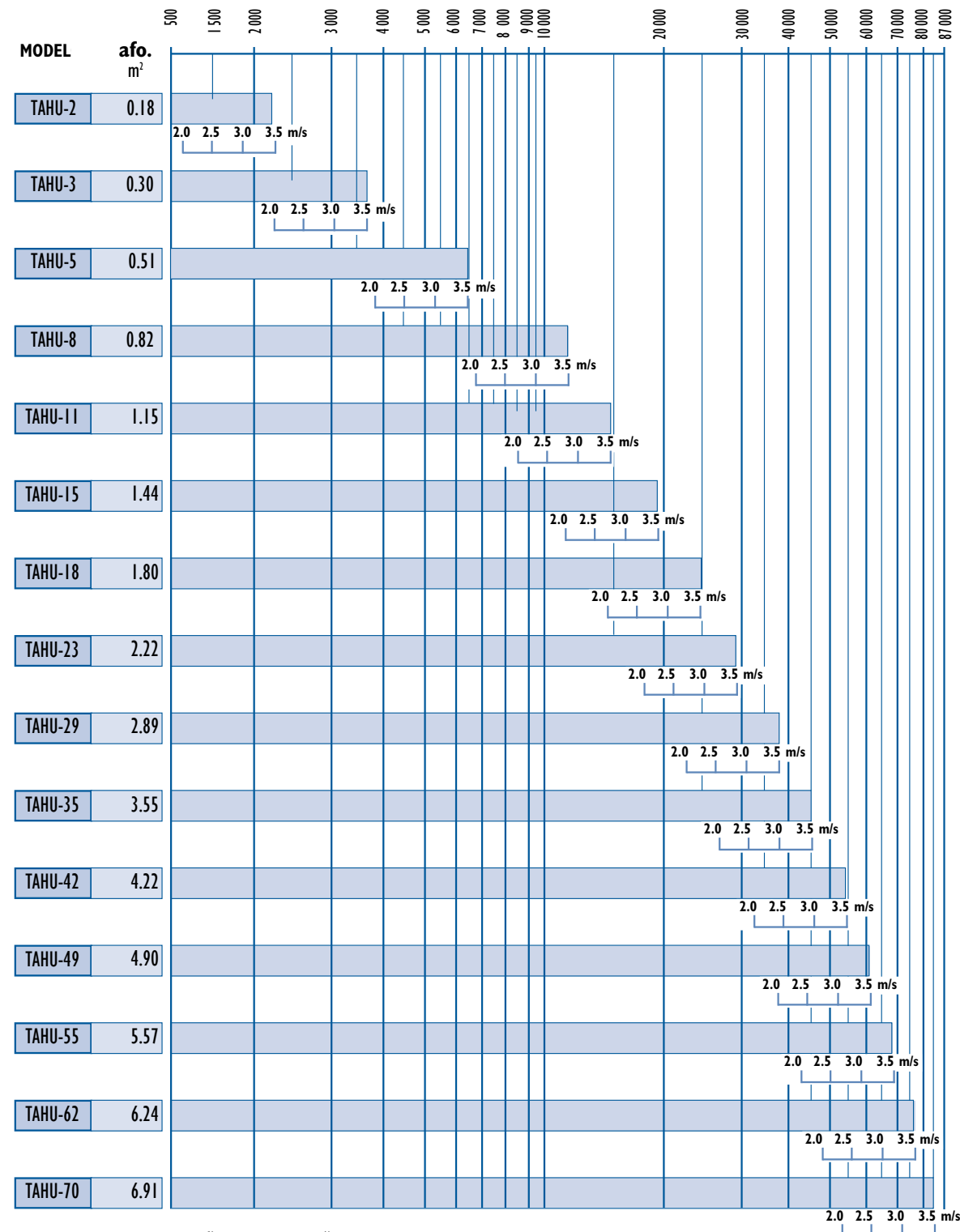

SELECTION DIAGRAM Air flow rate, in m³/h.

Selection in a sample project

Horizontal air handling unit, composed of the following sections:

- ▶ Air mixture.
- ▶ Extended surface filters.
- ▶ Cooling unit based on chilled water.
- ▶ Hot-water heating unit.
- ▶ Low-pressure fan section.
- ▶ Technical data:
 - ▶ Air flow rate: 19,200 m³/h;
 - ▶ Available static pressure: 45 mm w.g.;
 - ▶ Cooling power: 99,100 -kcal/h;
 - ▶ Chilled water temperature: 7°C;
 - ▶ Temp. Difference of chilled water: 5°C;
 - ▶ Conditions of inlet air: 26.4°C BS, 48% RH;
 - ▶ Conditions of outlet air: 13°C BS, 92% RH;
 - ▶ Temperature rise of motor: approx. 1°C;
 - ▶ Heating power: 69,120 kcal/h;
 - ▶ Hot water temperature: 85°C;
 - ▶ Temp. Difference of heated water: 15°C;
 - ▶ Conditions of inlet air: 18.0°C BS;
 - ▶ Conditions of outlet air: 30.0°C BS.

TAHU Air Handling Unit Selection (TOUFAN)
Using the quick selection table, the appropriate model for a flow rate of air of 19,200 m³/h and an air velocity of 2.7 m/s is the TAHU-23 with a front surface (afo) of 2.22 m².

Step 1:

To determine the air velocity through the unit: First, divide the flow rate of air expressed in

Section	Pressure drops in mm w.g.				
	Air velocity, m/s				
	2.50	2.75	3.00	3.25	3.50
E	2	2	3	3	4
M	2	2	3	3	4
FC	2	2	3	3	4
F	9	11	13	15	18
FB	19	23	27		
FA	56	58	60		
S-234 (700 mm)	2	2	3	3	4
S-334 (1050 mm)	2	3	3	4	5
S-434 (1400 mm)	3	3	4	4	5
S-534 (1750 mm)	3	4	4	5	6
HP	11	13	15		
HL	8	9	10		
BF 2R	5	6			
BF 3R	7	8			
BF 4R	9	10			
BF 5R	10	12			
BF 6R	12	14			
BC 1R	3	3	4	4	5
BC 2R	4	5	6	7	7
BC 3R	6	7	8	9	10
BC 4R	7	8	9	11	12

Code	Section
E	Air inlet
M	Air mixture
FC	Free Cooling
F	Extended surface filters
FB	Bag filters
FA	Absolute filters
BF	Cooling unit
BC	Heating unit
A	Access
HP	Panel humidifier
HL	Air scrubber humidifier
V	Fan
S	Silencer

600 m3/h by 3600 seconds to obtain the flow rate of air in m3/s:

$$19.200 / 3.600 = 5,33 \text{ m}^3/\text{s}$$

Divide this flow rate, in m3/s, by the afo for the TAHU-23 air handling unit, in m2, to obtain the air velocity in m/s:

$$\text{Air velocity through heating/cooling unit} = 5,33/2,22 = 2,4 \text{ m/s}$$

Step 2:

To determine the number of rows and depth of each cooling and heating unit, with an air velocity of 2.4 m/s:

Cooling, water at 7-12°C, 99100 -kcal/h = 4R
Heating, water 85/70°C, 69120 kcal/h = 1R

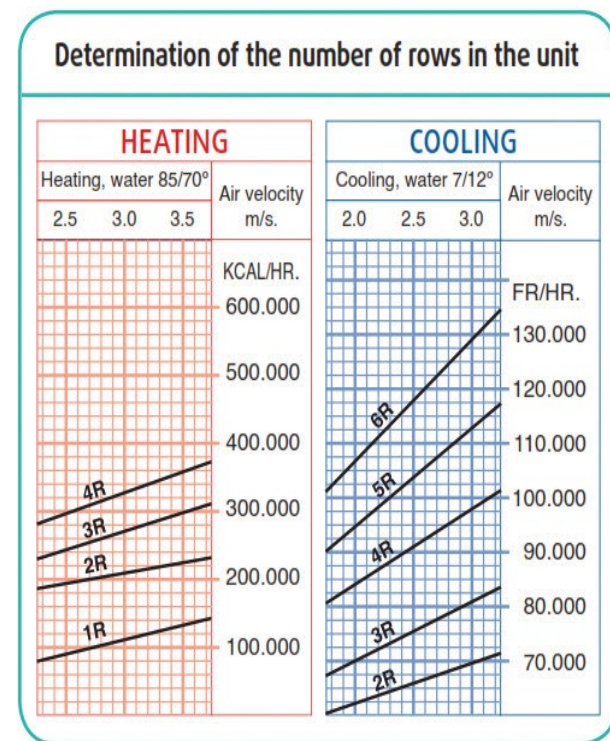

Step 3:

Determine the static pressure of the air handling unit by adding the various pressure drops for the unit for an air velocity of 2.4 m/s:

- _ Air mixing section (M) 2 mm w.g.
- _ Extended surface filter section (F) 9 mm w.g.
- _ Heating unit (BC) 1R 3 mm w.g.
- _ Cooling unit (BF) 4R 9 mm w.g.

Total sum for the air handling unit 23 mm w.g.

- _ Available static pressure 45 mm w.g.

Total static pressure 68 mm w.g.

Step 4:

Determine the operating conditions of the fan, in this case for low speed, ADH 560 model, on the respective curves:

The pressures indicated on the curves are "total pressures".

Therefore, the dynamic pressure (Pd) for 19,200 m3/h of air flow must be added to the static pressure obtained earlier:

$$\text{Total pressure (Pd + Pe)} = 6,5 \text{ mm} + 68 \text{ mm} = 74,5 \text{ mm w.g.}$$

$$\text{Total pressure increase (Pt)} 74,5 \text{ mm w.g.} = 74,5 \times 9,80665 = 730,6 = \text{approx. } 731 \text{ Pa}$$

The following values are obtained from the intersection of the air flowrate and total pressure:

Revolutions: 750 r.p.m. Input power: 6,0 kw
Sound power: 87 dB Efficiency: 66 %
Air outlet velocity: 10,2 m/s
The input power can then be used to calculate the motor output:

$$\text{Motor output} = 6,0 \text{ kw.} \times 1,2 = 7,2 \text{ kw (10=HP)}$$

Step 5:

SECTION WEIGHTS			
Sections	Kg	Sections	Kg
E	26	HP	100
M	33	HL	190
FC	56	V (w/o motor)	53
F	22	BF 2R	46
FB	40	BF 3R	51
FA	55	BF 4R	55
A (Each 1/5-mm clear)	11	BF 5R	59
S-234 (700 mm)	32	BF 6R	63
S-334 (1050 mm)	37	BC 1R	29
S-434 (1400 mm)	42	BC 2R	33
S-534 (1750 mm)	47	BC 3R	38
		BC 4R	42
Bedplate - weight per metre			16

MOTOR WEIGHTS			
Power (HP)	Kg	Power (HP)	Kg
0,33	5	1,5	16
0,5	5	2	16
0,75	9	3	30
1	9		

Determine the dimensions and weight of the air handling unit:

Section	Dimensions	Weights
M	920 mm	202 kg
F	175 mm	39 kg
BC(1 R)	175 mm	78 kg
BF (4 R)	525 mm	180 kg
V(without motor)	1.445mm	342 kg
10 HP motor		52 kg

TOTAL 3.240 mm 893 kg



The air handling unit will have the following dimensions and weight:

- Length 3.240 mm**
- Width 2.190 mm**
- Height 1.490 mm**
- Weight 893 kg**

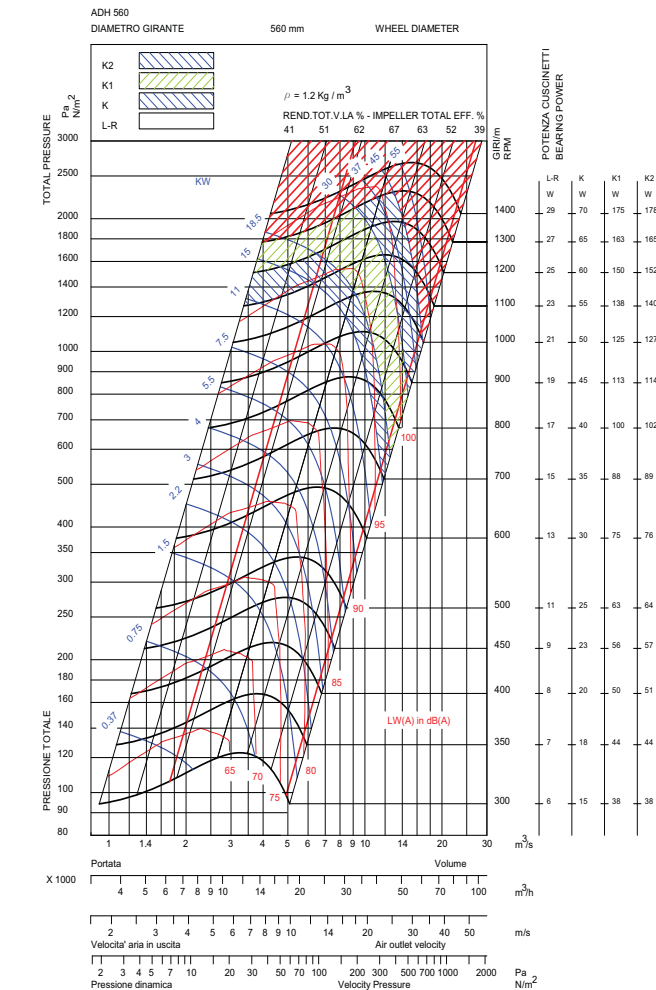
The air outlet mouth air are 721 x 721 mm.
The air inlets are 800 x 1700 x 672 x 1900 mm.

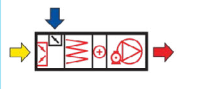
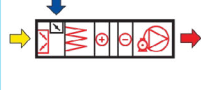

Dimensions and Weights

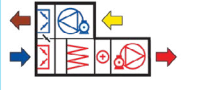
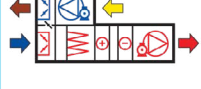
UNITS WITH MIXING SECTION		SIZE															
		2	3	5	8	11	15	18	23	29	35	42	49	55	62	70	
Panel 25	Width	760	760	1130	1130	1480	1480	1830	2190	2190	2190	2540	2890	3240	3590	3940	
	Height ¹⁾	585	760	780	1130	1130	1480	1480	1490	1840	2190	2190	2190	2190	2190	2190	
Panel 50	Width	810	810	1180	1180	1530	1530	1880	2230	2230	2230	2590	2920	3290	3620	3990	
	Height ¹⁾	635	810	830	1180	1180	1530	1530	1530	1880	2230	2230	2230	2230	2230	2230	
TAHU-1N 	Panel 25	Length	1810	1985	2180	2355	2705	2705	2880	3240	3415	3765	3940	4115	4290	4290	4290
		Weight ²⁾	215	254	361	467	606	729	862	1273	1469	1716	2135	2403	2685	2967	3234
	Panel 50	Length	1890	2065	2240	2415	2765	2765	2940	3290	3465	3815	3990	4165	4340	4340	4340
		Weight ²⁾	229	276	383	489	628	751	884	1304	1514	1761	2180	2448	2730	3012	3294
TAHU-2N 	Panel 25	Length	2335	2510	2705	2880	3230	3230	3405	3765	3940	4290	4465	4640	4815	4815	
		Weight ²⁾	283	341	472	610	765	920	1069	1564	1823	2115	2557	2852	3178	3497	3816
	Panel 50	Length	2415	2590	2765	2940	3290	3290	3465	3815	3990	4340	4515	4690	4865	4865	4865
		Weight ²⁾	303	372	493	638	799	960	1116	1603	1868	2167	2620	2922	3241	3560	3879
TAHU-3N 	Panel 25	Length	2685	3210	3580	3930	4630	4630	4980	5690	6390	6740	7090	7790	8140	8140	
		Weight ²⁾	339	416	512	734	960	1138	1347	2037	2403	2767	3513	4013	4495	4822	5149
	Panel 50	Length	2765	3290	3640	3990	4690	4690	5040	5740	6440	6790	7140	7840	8190	8190	8190
		Weight ²⁾	362	445	606	766	1003	1188	1405	2087	2462	2835	3599	4111	4605	5177	5504
TAHU-4N 	Panel 25	Length	3150	3675	4025	4375	5075	5075	5425	6125	6825	7175	7525	8225	8575	8575	
		Weight ²⁾	408	499	617	877	1124	1338	1569	2329	2748	3163	3942	4477	4944	5323	5650
	Panel 50	Length	3290	3815	4165	4515	5215	5215	5565	6265	6965	7315	7665	8365	8715	8715	8715
		Weight ²⁾	436	533	715	916	1175	1396	1637	2410	2816	3241	4039	4586	5117	5464	5791
		SIZE															
Panel 25	Width	760	760	1130	1130	1480	1480	1830	2190	2190	2190	2540	2890	3240	3590	3940	
	Height ¹⁾	1170	1520	1560	2260	2260	2960	2960	2980	3680	4380	4380	4380	4380	4380	4380	
Panel 50	Width	810	810	1180	1180	1530	1530	1880	2230	2230	2230	2590	2920	3290	3620	3990	
	Height ¹⁾	1270	1620	1660	2360	2360	3060	3060	3060	3760	4460	4460	4460	4460	4460	4460	
TAHU-5N 	Panel 25	Length	1810	1985	2180	2355	2705	2705	2880	3240	3415	3765	3940	4115	4290	4290	
		Weight ²⁾	339	416	512	734	960	1138	1347	2037	2403	2767	3513	4013	4495	4822	5149
	Panel 50	Length	1890	2065	2240	2415	2765	2765	2940	3290	3465	3815	3990	4165	4340	4340	4340
		Weight ²⁾	362	445	606	766	1003	1188	1405	2087	2462	2835	3599	4111	4605	5177	5504
TAHU-6N 	Panel 25	Length	2335	2510	2705	2880	3230	3230	3405	3765	3940	4290	4465	4640	4815	4815	
		Weight ²⁾	408	499	617	878	1124	1338	1569	2329	2748	3163	3942	4477	4944	5323	5650
	Panel 50	Length	2415	2590	2765	2940	3290	3290	3465	3815	3990	4340	4515	4690	4865	4865	4865
		Weight ²⁾	436	534	715	916	1175	1396	1637	2170	2816	3241	4039	4586	5117	5464	5791

 = outdoor air
  = supply air
  = extract air
  = exhaust air

Dimensions in mm. Weights in kg.

1) Does not include the height of the metal frame.

2) Does not include the weight of the metal frame.

Mechanical Specifications:

Performance Climate Changer air handlers must be rigged, lifted, and installed in strict accordance with the Installation, Operation, and Maintenance manual for Performance air handlers. The units are also to be installed in strict accordance with the specifications.

All units will be shipped with an integral base frame designed with the necessary number of lift points for safe installation. The lift points will be designed to accept standard rigging devices and be removable after installation. Units shipped in sections will have a minimum of four points of lift. Units will also be shipped with a shipping skid designed for forklift transport.

Units will be shipped with a shipping skid designed for forklift transport and the integral base will be designed with the necessary number of lift points for safe installation. The lift points will be designed to accept standard rigging devices and removable after installation. Units shipped in sections will have a minimum of four points of lift.

Per ASHRAE 62.1 recommendation, units will be shipped stretch-wrapped to protect unit from in transit rain and debris. Installing Contractor is responsible for long-term storage in accordance with the Installation, Operation, and Maintenance manual.

Air-handling performance data shall be certified in accordance with AHRI Standard 430. Unit sound performance data shall be provided using AHRI Standard 260 test

methods and reported as sound power. Coil performance shall be certified in accordance with AHRI Standard 410.

Seismic Specification:

TOUFAN TAHVIEH has qualified air-handling units in accordance with the following International Building Code (IBC) releases: IBC 2000, 2003, 2006, 2009.

Structural floors, housekeeping pads, supporting curbs, and supporting steel must be seismically designed and approved by the project or building Structural Engineer of Record to withstand the seismic anchor loads. Installation details such as special inspection, attachment to a curb, or attachment to a non-building structure must be outlined and approved by the Engineer of Record for the project or building. The installing contractor shall be responsible for the proper installation

Unit Construction Casing Construction

All unit panels shall be 2-inch solid, double-wall construction to facilitate cleaning of unit interior. Unit panels shall be provided with a mid-span, no through metal, internal thermal break. Casing thermal performance shall be such that under 55°F supply air temperature and design conditions on the exterior of the unit of 81°F dry bulb and 73°F wet bulb, condensation shall not form on the casing exterior.

All exterior and interior AHU panels will be made of galvanized steel. Optionally, all

interior AHU casing panels will be made of stainless steel.

The casing shall be able to withstand up to 8 inches w.g. positive or negative static pressure. The casing shall not exceed 0.0042 inch deflection per inch of panel span at 1.5 times design static pressure up to a maximum of +8 inches w.g. in all positive pressure sections and -8 inches w.g. in all negative pressure sections.

Unit Flooring

The unit floor shall be of sufficient strength to support a 300-lb. load during maintenance activities and shall deflect no more than 0.0042 inch per inch of panel span.

Casing Leakage

The casing air leakage shall not exceed leak class 9 (CL = 9) per ASHRAE 111 at 1.25 times maximum casing static pressure (P in inches w.g.), up to a maximum of +8 inches w.g. in all positive pressure sections and -8 inches w.g. in all negative pressure sections, where maximum casing leakage (cfm/ 100 ft² of casing surface area) = CL x P 0.65 .
Optionally, the casing air leakage shall not exceed leak class 6 (CL = 6) per ASHRAE 111 at 1.25 times maximum casing static pressure (P in inches w.g.), up to a maximum of +8 inches w.g. in all positive pressure sections and -8 inches w.g. in all negative pressure sections, where maximum casing leakage (cfm/100 ft² of casing surface area) = C L x P 0.65 .

Insulation

Panel insulation shall provide a minimum thermal resistance (R) value of 13 ft²•h•°F/ Btu throughout the entire unit. Insulation shall completely fill the panel cavities in all directions so that no voids exist and settling of insulation is prevented. Panel insulation shall comply with NFPA 90A.

Drain Pans

All cooling coil sections shall be provided with an insulated, double-wall, galvanized or stainless steel drain pan. To address indoor air quality (IAQ), the drain pan shall be designed in accordance with ASHRAE 62.1 being of sufficient size to collect all condensation produced from the coil and sloped in two planes promoting positive drainage to eliminate stagnant water conditions. The outlet shall be located at the lowest point of the pan and shall be sufficient diameter to preclude drain pan overflow under any normally expected operating condition. All drain pan threaded connections shall be visible external to the unit. Drain connections shall be of the same material as the primary drain pan and shall extend a minimum of 2 1/2 inches beyond the base to ensure adequate room for field piping of condensate drain traps. Coil support members inside the drain pan shall be of the same material as the drain pan and coil casing. Heating coil, access, and mixing

sections may be provided with an optional IAQ drain pan.

Access Doors

Access doors shall be 2-inch double-wall construction. Interior and exterior door panels shall be of the same construction as the interior and exterior wall panels, respectively. All doors downstream of cooling coils shall be provided with a thermal break construction of door panel and door frame. Gasketing shall be provided around the full perimeter of the doors to prevent air leakage. Surface-mounted handles shall be provided to allow quick access to the interior of the functional section and to prevent through-cabinet penetrations that could likely weaken the casing leakage and thermal performance. Handle hardware shall be designed to prevent unintended closure. Access doors shall be hinged and removable for quick, easy access. Hinges shall be interchangeable with the door handle hardware to allow for alternating door swing in the field to minimize access interference due to unforeseen job site obstructions. Door handle hardware shall be adjustable and visually indicate locking position of door latch external to the section. Optionally, a single-handle door shall be provided for all outward swinging doors linked to multiple latching points necessary to maintain the specified air leakage integrity of the unit.

View Windows

An optional shatterproof window for viewing, capable of withstanding unit operating pressures, shall be provided in the door.

Marine Lights

A factory-mounted, weather-resistant (enclosed and gasketed to prevent water and dust intrusion), light emitting diode (LED) fixture shall be provided in sections of the unit as specified for maintenance and service visibility. Fixture shall be complete with aluminum die cast housing, polycarbonate lens designed for maximum light output, and LEDs wired to a single switch within a factory-provided service module. LED lighting shall provide instant-on white light and have a minimum 50,000 hour life. Fixtures shall be designed for flexible positioning during maintenance and service activities for optimal location.

All lights within the unit shall be wired to a single switch within the factory provided service module. The service module shall include a GFCI receptacle separate from the load side of the equipment. Electrical contractor shall be required to provide a 120V supply to the factory-mounted service module for the marine light circuit (unless single-point power is provided) and always for the GFCI receptacle circuit per NEC. The service module shall be provided on the fan section, unless a controls section is

provided. In which case, the service module will be provided on the controls section.

Fans

The fan type shall be provided as required for stable operation and optimum energy efficiency. The fan shall be statically and dynamically balanced at the factory as a complete fan assembly (fan wheel, motor, drive, and belts). The fan shaft shall not exceed 75 percent of its first critical speed at any cataloged speed. Fan wheels shall be keyed to the fan shaft to prevent slipping. The fan shafts shall be solid steel. The fan section shall be provided with an access door on the drive side of the fan.

FC Fan

The fan shall be a double-width, double-inlet, multi-blade-type, forward-curved (FC) fan. The fan shall be equipped with self-aligning, antifriction bearings with an L-50 life of 200,000 hours as calculated per ANSI/AFBMA Standard 9. Fan performance shall be certified as complying with AHRI Standard 430.

BC Fan

The fan shall be a double-width, double-inlet, multi-blade-type backward-curved (BC) fan. The fan shall be equipped with self-aligning, antifriction bearings with an L-50 life of 200,000 hours as calculated per ANSI/AFBMA Standard 9. Fan performance shall be

certified as complying with AHRI Standard 430.

AF Fan

The fan shall be a double-width, double-inlet, multi-blade-type, airfoil (AF) fan. The fan shall be equipped with self-aligning, antifriction bearings with an L-50 life of 200,000 hours, as calculated per ANSI/AFBMA Standard 9. Fan performance shall be certified as complying with AHRI Standard 430.

Direct-Drive Plenum Fan

The fan shall be a single-width, single-inlet, 9-blade or 12-blade plenum fan. The fan blades shall be aluminum backward-inclined airfoil. Plenum fan shall be direct-driven. Fan sections containing multiple fans shall be controlled using a common control signal, such as the duct static control signal, to modulate the fan speed.

Fan Isolation

All fans, including direct-drive plenum fans, shall be mounted on isolation bases and isolated from the unit casing by a flexible connection.

1-Inch, Seismic Spring Isolators

The fan and motor assembly shall be internally isolated from the unit casing with 1-inch (25.3-mm) deflection spring isolators, furnished and installed by the unit

manufacturer. The isolation system shall be designed to resist loads produced by external forces, such as earthquakes, and conform to the current IBC seismic requirements.

2-Inch, Seismic Spring Isolators

The fan and motor assembly shall be internally isolated from the unit casing with 2-inch (50.8-mm) deflection spring isolators, furnished and installed by the unit manufacturer. The isolation system shall be designed to resist loads produced by external forces, such as earthquakes, and conform to the current IBC seismic requirements.

Fan Drives

Variable Pitch: The drives shall be variable pitch, suitable for adjustment speed.

Fixed Pitch: The drives shall be constant speed with fixed-pitch sheaves.

Fan Motors

The motor shall be integrally mounted to an isolated fan assembly furnished by the unit manufacturer. The motor shall be mounted inside the unit casing on an adjustable base to permit adjustment of drive-belt tension. The motor shall meet or exceed all NEMA Standards Publication MG1 requirements and comply with NEMA premium efficiency levels when applicable. The motor shall have T-frame, squirrel cage with size, type, and electrical characteristics as shown on the

equipment schedule.

Grease Lines

Bearings are selectable with life-time lubrication or with re-lubrication required. For any bearing requiring re-lubrication, the grease line shall be extended to the fan support bracket on the drive side of the fan.

Fan Section Options

Multiple Belt Drive

The fan section shall have motor leads extended to a factory-installed NEMA 4 external junction box to facilitate motor wiring and to maintain air leakage integrity of the casing.

Motor wiring conduit

The fan motor wiring shall be factory-wired to the unit-mounted starter/disconnect, variable frequency drive (VFD), or external motor junction box within flexible metal conduit of adequate length so that the fan vibration isolation will not be restricted.

Flow Meter

The fan shall have an airflow measurement system to measure fan airflow directly or to measure differential pressure that can be used to calculate fan airflow. The system shall predict airflow within +/-5 percent total accuracy (device and transmitter) when operating within the stable operating region

of the fan curve. The submitted fan airflow performance and noise levels shall not be affected by the installation of the device. Any device that provides an obstruction to the fan inlet will not be accepted.

Belt Guard

Fan sections with centrifugal housed fans shall be provided with a corrosion-proof, wire mesh belt guard to deter incidental contact with rotating sheaves and belts.

Coils

Coils shall be manufactured by the supplier of the air handling unit and installed such that headers and return bends are enclosed by unit casing. Coils shall be removable by unbolting the wall panels in the coil section. Coil connections shall be clearly labeled on unit exterior. Fin surfaces shall be cleaned prior to installation in the unit to remove any oil or dirt that may have accumulated on the fin surfaces during manufacturing of the coil.

Horizontal and Vertical Coil Sections

The coil section shall be provided complete with coil and coil holding frame. Coil section side panels shall be easily removable to allow for removal and replacement of coils without impacting the structural integrity of the unit. The coils shall be installed such that headers and return bends are enclosed by unit casings. If two or more cooling coils are stacked in the unit, an intermediate drain pan shall be installed between each coil.

Like the primary drain pan, the intermediate drain pan shall be designed being of sufficient size to collect all condensation produced from the coil and sloped to promote positive drainage to eliminate stagnant water conditions. The intermediate pan shall begin at the leading face of the water-producing device and be of sufficient length extending downstream to prevent condensate from passing through the air stream of the lower coil. Intermediate drain pan shall include downspouts to direct condensate to the primary drain pan. The outlet shall be located at the lowest point of the pan and shall be sufficient diameter to preclude drain pan overflow under any normally expected operating condition.

Inspection Section

The coil section shall include an inspection section complete with a double-wall, removable door downstream of the coil for inspection, cleaning, and maintenance. Interior and exterior door panels shall be of the same construction as the interior and exterior wall panels, respectively. All doors downstream of cooling coils shall be provided with a thermal break construction of door panel and door frame.

Water Coils

The coils shall have aluminum fins and seamless copper tubes. Copper fins may be applied to coils with 5/8-inch tubes. Fins shall have collars drawn, belled, and firmly bonded to tubes by mechanical expansion of the tubes. The coil casing may be galvanized

or stainless steel. The coils shall be proof-tested to 300 psig and leak-tested under water to 200 psig. Coil performance data and coils containing water or ethylene glycol shall be certified in accordance with AHRI Standard 410.

Propylene glycol and calcium chloride, or mixtures thereof, are outside the scope of AHRI Standard 410 and, therefore, do not require AHRI 410 rating or certification.

Headers are to be constructed of round copper pipe or cast iron.

- Tubes shall be 1/2-inch OD, 0.016-inch copper.
- Tubes shall be 1/2-inch OD, 0.025-inch copper.
- Tubes shall be 5/8-inch OD, 0.020-inch copper.
- Tubes shall be 5/8-inch OD, 0.024-inch copper.
- Tubes shall be 5/8-inch OD, 0.035-inch copper.

Hydronic coils may be supplied with factory installed drain and vent piping to unit casing exterior.

Refrigerant Cooling Coils

The coils shall have aluminum fins and seamless copper tubes. The fins shall have collars drawn, belled, and firmly bonded to tubes by mechanical expansion of the tubes. The coil casing may be galvanized or stainless steel. Suction and liquid line

connections shall extend to the unit exterior. The coils shall be proof-tested to 450 psig and leak-tested to 300 psig air pressure under water. After testing, the inside of the coils shall be dried, all connections shall be sealed, and the coil shall be shipped with a charge of dry nitrogen. Suction headers shall be constructed of copper tubing with connections penetrating unit casings to permit sweat connections to refrigerant lines. The coils shall have equalizing vertical distributors sized according to the capacities of the coils. Coil performance data shall be certified in accordance with AHRI Standard 410.

- Tubes shall be 1/2-inch OD, 0.016-inch copper.
- Tubes shall be 1/2-inch OD, 0.025-inch copper.

Steam Heating Coil

The coils shall have aluminum fins and seamless copper tubes. Copper fins may be applied to coils with 1-inch tubes. The fins shall have collars drawn, belled, and firmly bonded to tubes by mechanical expansion of the tubes. The coil casing may be galvanized or stainless steel. Non-freeze, steam-distributing-type coils shall be provided. Steam coils shall be pitched in the unit for proper drainage of steam condensate from coils. The coils shall be proof-tested to 300 psig and leak tested to 200 psig air pressure under water. Headers are to be constructed of cast iron. Inner tubes shall have orifices

that ensure even steam distribution throughout the full length of the outer tube. Orifices shall be directed toward the return connections to ensure that the steam condensate is adequately removed from the coil. Coil performance data shall be certified in accordance with AHRI Standard 410.

- Tube construction shall be a 11/16-inch OD, 0.031-inch copper inner tube with a 1-inch OD, 0.031 copper outer tube.
- Tube construction shall be a 11/16-inch OD, 0.031-inch copper inner tube with a 1-inch OD, 0.049-inch red brass outer tube.

Coil Coating

The coil shall have a flexible epoxy polymer e-coat uniformly applied to all coil surface areas without material bridging between fins. Coating process shall ensure complete coil encapsulation and a uniform dry film thickness from 0.8 - 1.2 mil on all surface areas including fin edges. Superior hardness characteristics of 2H per ASTM D3363-92A and a cross-hatch adhesion of 4B-5B per ASTM B3359-93. Impact resistance shall be up to 160 in/lb. per ASTM D2794-93. Humidity and water immersion resistance shall be up to a minimum 1000 and 260 hours respectively (ASTM D2247-92 and ASTM D870-02). Corrosion durability shall be confirmed through testing to no less than 5,000 hours salt spray per ASTM B117-90 using scribed aluminum test coupons.

Electric Heat Coil Section

A recognized electric heater shall be factory-installed in the air handler. The heater shall be an open-coil configuration with Type A wire (80% nickel and 20% chromium) derated to a maximum watt density of 45 watts per square inch. Safeties shall include three-pole, disconnecting-type contactors, airflow switches, automatic-reset functional limits, automatic-reset high-temperature limits, and manual-reset high-temperature limits. The contactors for energizing the electric heater shall be magnetic contactors.

Dampers

Barometric Relief Dampers

The frame shall be roll formed galvanized steel. Blades shall be roll formed galvanized steel. Blade seals shall be extruded vinyl, mechanically attached to the blade edge. Damper sections up to 24 inches wide shall be galvanized steel single tie bar linkage. Damper sections larger than 24 inches wide shall be double tie bar linkage. Damper sections up to 42 inches wide shall axle assembly mechanically locked onto the blade edge. Damper sections larger than 42 inches wide shall be axle and blade bracket assembly.

Damper Performance and Operating Conditions

The operating temperature range is -40F to 200F. Manufacturer must be able to demonstrate structural capacity of damper to withstand maximum system air velocity of 3,000 fpm when fully open. Manufacturer must be able to demonstrate structural capacity of damper to withstand maximum system back pressure of 6 inches w.g. in the closed position. Pressure drop shall be maximum 0.1 inch w.g. at 1,000 fpm across a fully open 24 inch x 24 inch damper. Damper pressure drop ratings shall be in accordance with Air Movement and Control Association (AMCA) 500.

Dimensions and Tolerances - In addition to the dimensions and tolerances shown on the applicable drawing, the following dimension tolerance criteria must be met:

- Mounting flange slot tolerance: -0/+0.031
- All sheet metal brake angles: +/- 3 degrees
- Overall frame size: +0/-0.125
- Mounting flange flatness:
- Overall dimension 48 inches and under: 0.062:/ft
- Over 48 inches: within 0.25 inch overall

Packing and Shipping - Dampers shall be prepared for shipment in accordance with commercial practice to assure carrier acceptance and safe transportation to the point of delivery. Packaging shall conform to carrier rules and regulations applicable to the mode of transportation.

Humidifiers

Direc Steam

Humidifier section shall be provided with a humidifier panel designed for building steam. Humidifier panel shall include stainless steel construction of all wetted parts including the header/ separator and multiple tube dispersion assembly. Tube-to-header joints shall consist of welded stainless steel. Humidifier shall provide a uniform steam discharge. Humidifiers shall be provided with a steam separator, control valve, inverted bucket steam trap, wye strainer, and two float and thermostatic steam traps shipped loose for field installation. All pipe connections shall be made from one side of the air handler.

Atmospheric steam

Humidifier section shall be provided with a humidifier panel designed for atmospheric steam. Humidifier panel shall include stainless steel construction of all wetted parts including the header/ separator and multiple tube dispersion assembly. Tube-to-header joints shall consist of welded stainless steel. Humidifier shall provide a uniform steam discharge. All pipe connections shall be made from one side of the air handler.

Filters and Air Cleaners

Filter sections shall have filter racks, at least one access door for filter removal, and filter block-offs to prevent air bypass around filters. The filter sections shall be supplied with 2-inch or 4-inch flat, or 2-inch or 4-inch angled, bag, or cartridge filters.

Permanent Filters

The filters shall be 2-inch, all-metal, viscous-imprisonment type, capable of operating up to 625-fpm face velocity without loss of filter efficiency and holding capacity. The filter media shall be layers of cleanable wire mesh. The filter frame shall be constructed of galvanized steel. The filters shall have a MERV 2 rating when tested in accordance with the ANSI/ASHRAE Standard 52.2.

Throwaway Filters

The filters shall be throwaway-type and shall have 2-inch fiberglass media contained in a rigid frame. Filters shall be capable of operating up to 500-fpm face velocity without loss of filter efficiency and holding capacity. Filters shall have a rigid supporting mesh across the leaving face of the media. The filters shall have a MERV 5 rating when tested in accordance with the ANSI/ASHRAE Standard 52.2.

Pleated Media Filters

The filters shall be 2-inch or 4 inch, made with 100 percent synthetic fibers that are continuously laminated to a supported steel-wire grid with water repellent adhesive. Filters shall be capable of operating up to 625-fpm face velocity without loss of filter efficiency and holding capacity. The filters shall have a MERV 8 rating when tested in accordance with the ANSI/ASHRAE Standard 52.2.

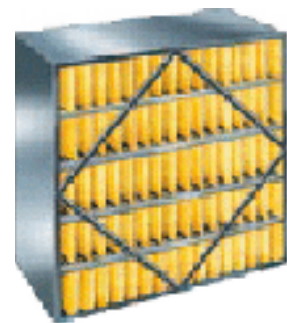
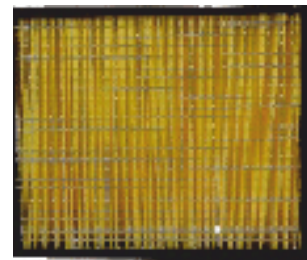

Bag Filters

The filters shall be fine-fiber, all-glass media with spun backing to keep glass fibers from eroding downstream. The stitching method shall permit the bag to retain its pleated shape without the use of a wire-basket support. The filters shall be capable of operating up to 625-fpm face velocity without loss of filter efficiency and holding capacity. The filters shall be sealed into a metal header. A gasket material shall be installed on the metal header of the filter to prevent filter bypass where the metal headers meet the side-access racks. All bag filters shall be furnished with a 2-inch pleated media MERV 8 pre-filter to extend bag filter life. The manufacturer shall supply a side-access filter rack capable of holding bag filters and pre-filters. The filters shall have a MERV 12 to 14 rating when tested in accordance with the ANSI/ASHRAE Standard 52.2.



Cartridge Filters

The filters shall be constructed with a continuous sheet of fine-fiber media made into closely spaced pleats. The filters shall be capable of operating up to 625-fpm face velocity for 12-inch deep filters without loss of filter efficiency and holding capacity. The filters shall be sealed into a metal frame assembled in a rigid manner. A gasket material shall be installed on the metal header of the filter to prevent filter bypass where the metal headers meet on the side-access racks. All cartridge filters shall be furnished with a 2-inch pleated media MERV 8 pre-filter to provide extended cartridge life. The manufacturer shall supply a side-access filter rack capable of holding cartridge filters and pre-filters. Cartridge filters shall have a MERV 11 to 15 rating when tested in accordance with the ANSI/ASHRAE Standard 52.2.



4-Inch High-Efficiency Filters

The filters shall be constructed with a fine fiber media made into closely spaced pleats. The filters shall be capable of operating up to 625-fpm face velocity without loss of filter efficiency and holding capacity. The filter media shall be sealed into a frame assembled in a rigid manner. All 4-inch high efficiency filters shall be furnished with a 2-inch pre-filter to provide extended filter life. The manufacturer shall supply a side-access filter rack capable of holding 4-inch high-efficiency filters and pre-filters. The filters shall have a MERV 11 to 14 rating when tested in accordance with the ANSI/ASHRAE Standard 52.2.

HEPA Filters

The HEPA filter cells shall be enclosed in a galvanized steel frame with neoprene rubber applied to the leaving-air side of the filter cell to reduce air leakage. Continuously welded, front-load filter frames with filter holding clips shall be mounted inside the section casing and shall be gasketed to prevent leakage or air bypass. Filter clips shall require tooling in order to tighten and hold filter cells to frame. Filter media shall be produced from glass waterproof microfiber with a continuous pleat and aluminum separates between pleat folds. Filters shall be capable of operating up to 500- fpm face velocity without loss of filter efficiency and holding capacity. HEPA filter efficiency shall be not less than 99.97

percent when tested in accordance with ASHRAE 52.1 atmospheric dust spot method. Although not covered by MERV ratings, HEPA filters shall be not less than an equivalent 17 when tested in accordance with ASHRAE 52.2.

Ultraviolet (UVC) Lights

UV-C light fixtures and lamps shall be provided by the air handler manufacturer. The UV-C fixtures shall be factory-assembled and tested in the air handler. Lamp life shall be 9,000 hours minimum with no more than a 20% loss of output after two years of continuous use. The UV-C fixtures and lamps shall be coupled end-to-end and mounted on a slide-out rack to enable complete replacement and/or maintenance of the bulbs from the unit exterior. Fixtures shall meet the UL drip-proof design criteria. Fixtures shall be constructed of stainless steel to resist corrosion. Fixtures shall have been tested and recognized by UL/C-UL under Category Code ABQK (Accessories, Air Duct Mounted), UL Standards 153, 1598 & 1995. All polymeric materials that come into direct or indirect (reflected) contact with UV-C light shall be UV-C resistant or shielded from the UV-C light using a certified UV-C tolerant material such as metal. Access doors shall be provided at the location of each UV-C light as indicated on the plans and schedule. A view port with cover shall be provided to allow viewing of the UV-C light array to confirm operation. The view port and other AHU windows shall be treated to

assure the UV-C energy emitted through it is below the threshold limits specified by NIOSH and ACGIH.

All sections of the handler with access doors where the UV-C lights may pose a risk for direct exposure shall have a mechanical interlock switch that disconnects power to the lights when the door is opened. Each UV section shall also be equipped with an externally mounted on-off/ disconnect/shut off switch that disconnects power to the UV-C lights. The switch shall be equipped with a lock-out/tag-out to prevent unwanted operation of the UV-C lights.

Filter Section Options

Differential Pressure Gauge

A factory-installed dial type differential pressure gauge shall be piped to both sides of the filter to indicate status. Gage shall maintain a +/- 5 percent accuracy within operating temperature limits of -20°F to 120°F. Gage shall be flush mounted with casing outer wall. Filter sections consisting of pre- and post-filters shall have a gage for each.

Mixing Section

Mixing Section, Filter Mixing Section, Airflow Measurement Station, and Economizer Sections

A functional section shall be provided to support the damper assembly for outdoor, return, and/ or exhaust air.

Dampers

Dampers shall modulate the volume of outdoor, return, or exhaust air. The dampers shall be of double-skin airfoil design with metal, compressible jamb seals and extruded-vinyl blade-edge seals on all blades. The blades shall rotate on stainless-steel sleeve bearings. The dampers shall be rated for a maximum leakage rate of 3 cfm/ft² at 1 in. w.g. complying with ASHRAE 90.1 maximum damper leakage. All leakage testing and pressure ratings shall be based on AMCA Standard 500-D. Dampers may be arranged in a parallel or opposed-blade configuration.

Airflow Measurement Station (Special Dampers)

A factory-mounted airflow measurement station tested in accordance with AMCA Standard 611 and bearing the AMCA Ratings Seal for Airflow Measurement Performance shall be provided in the outdoor and/or return air opening to measure airflow. The damper

blades shall be galvanized steel, housed in a galvanized steel frame and mechanically fastened to a rotating axle rod. The dampers shall be rated for a maximum leakage rate of 4 cfm/ft² at 1 in. w.g. complying with ASHRAE 90.1 maximum damper leakage. The standard Special airflow measurement station shall be capable of measuring from 15 percent to 100 percent of unit nominal airflow. Optionally, a low-flow Special airflow measurement station shall be capable of measuring from 7.5 percent to 100 percent (sizes 6-30) of unit nominal airflow. The airflow measurement station shall adjust for temperature variations and provide a 2 to 10 Vdc signal that corresponds to actual airflow for controlling and documenting airflow. The accuracy of the airflow measurement station shall be ±5 percent.

Internal and External Face-and-Bypass Damper Section

Dampers shall be provided as scheduled to divert airflow around the coil. Dampers shall be of double-skin airfoil design with metal, compressible jamb seals and extruded-vinyl blade-edge seals on all blades. The blades shall rotate on stainless-steel sleeve bearings. Dampers are arranged in an opposed-blade configuration and mechanically linked with jackshafts. The dampers shall be rated for a maximum leakage rate of 5 cfm/ft² at 1 in. w.g. All leakage testing and pressure ratings shall be based on AMCA Standard 500-D.

Internal Face Damper Section

Dampers shall be provided as scheduled within the air handler. Dampers shall be of double-skin airfoil design with metal, compressible jamb seals and extruded-vinyl blade-edge seals on all blades. The blades shall rotate on stainless-steel sleeve bearings. Dampers are arranged in an opposed-blade configuration and mechanically linked with jackshafts. The dampers shall be rated for a maximum leakage rate of 5 cfm/ft² at 1 in. w.g. All leakage testing and pressure ratings shall be based on AMCA Standard 500-D.

Multizone Sections

Two-Deck Multizone

Multizone section shall be provided with a cooling coil in the lower deck and a heating coil in the upper deck. Pressure drop equalization baffles shall be provided, as required, to balance air pressure drop through each deck. Multizone dampers for controlling airflow through the upper and lower decks shall be double-skin airfoil design with metal compressible jamb seals and extruded vinyl blade edge seals on all blades. Blades shall rotate on stainless steel sleeve bearings. The dampers are rated for a maximum leakage rate of 11 (cfm)/(foot squared) at 1 inch wg.

Three-Deck Multizone

Multizone section shall be provided with a cooling coil in the lower deck, a heating coil in the upper deck, and a bypass (neutral) center deck. Pressure drop equalization baffles shall be provided, as required, to balance air pressure drop through each deck. Multizone dampers for controlling airflow through the three decks shall be double-skin airfoil design with metal compressible jamb seals and extruded vinyl blade edge seals on all blades. Blades shall rotate on stainless steel sleeve bearings. The dampers are rated for a maximum leakage rate of 11 (cfm)/(foot squared) at 1 inch wg.

Double-Duct Section

Double duct section shall be provided with a cooling coil in the lower deck and a heating coil in the upper deck. Pressure drop equalization baffles shall be provided, as required, to balance air pressure drop through each deck.

Triple-Duct Section

Triple duct section shall be provided with a cooling coil in the lower deck, a heating coil in the upper deck, and a bypass (neutral) center deck. Pressure drop equalization baffles shall be provided, as required, to balance air pressure drop through each deck.

Paint Options

Outdoor Unit Paint

External surface of unit casing shall be prepared and coated with a minimum 1.5 mil enamel finish or equal. Units supplied with casing exterior factory-painted shall be able to withstand a salt spray test in accordance with ASTM B117 for a minimum of 500 consecutive hours. Unit casing exterior will be provided with manufacturer's standard color, or alternative color when required.

Optional Indoor Unit Paint

In indoor units all exterior AHU panels will be made of galvanized steel. As an option, the external surface of the unit casing can be painted upon request. Units supplied with factory-painted exterior casing shall be able to withstand a salt spray test in accordance with ASTM B117 for a minimum of 500 consecutive hours. Unit casing exterior will be provided with manufacturer's standard color, or alternative color when required.

Pipe Cabinet

For outdoor units, piping cabinet shall be supplied by the manufacturer (factory-assembled) and shall be of the same construction as the main unit casing. Piping cabinet shall be mounted external to the unit and shipped separate to be field-installed.

Outdoor Unit Roof

TOUFAN TAHVIEH engineered inner roofs incorporate mid-span, internal thermal breaks to eliminate thermal conduction paths from the interior of the air handler to the exterior (2-inch R13 foam-insulated). Inner/Indoor/ roof will be installed in such a manner as to prevent air bypass between internal components. A single layer Outer/Outdoor roof is utilized above the inner roof and will be sloped at a minimum 0.125inches per foot either from one side of unit to other or from center to sides of the unit. Roof assembly will overhang all walls of units by a 1.5-inch minimum.

Silencers

A rectangular silencer shall be provided to reduce airborne sound transmitted through the air handler. The silencer ratings for dynamic insertion loss and pressure drop shall be in accordance with ASTM E-477 for forward flow (air and noise in the same direction) or reverse flow (air and noise in the opposite direction) per the project's requirements. Acoustical performance within the air handler unit assembly shall be in accordance with AHRI 260.

Other Sections and Options

Access/Inspection Sections

A section shall be provided to allow additional access/inspection of unit components and space for field-installed components as needed. The section length shall be variable to accommodate specific access, spacing, or dimensional requirements. An access door shall be provided for easy access. All access sections shall be complete with a double-wall, removable door downstream for inspection, cleaning, and maintenance. Interior and exterior door panels shall be of the same construction as the interior and exterior wall panels, respectively. All doors downstream of cooling coils shall be provided with a thermal break construction of door panel and door frame.

Diffuser Section

A diffuser section shall be provided immediately downstream of the fan section. The diffuser shall provide equal air distribution to blow-thru components immediately downstream of the diffuser.

Turning and Discharge Plenum Sections

Plenums shall be provided to efficiently turn air and provide sound attenuation. Discharge plenum opening types and sizes shall be scaled to meet engineering requirements.

The vertical discharge plenum height may be scaled to accommodate the appropriate discharge duct height. The horizontal discharge plenum length may be scaled to accommodate necessary dimensional constraints.

Controls

Combination Starter–Disconnects

An IEC combination starter/disconnect shall be provided for each fan motor. Each starter / disconnect shall be properly sized, factory mounted in a full metal enclosure, and wired to the fan motor to facilitate temporary heating, cooling, ventilation, and/or timely completion of the project. Starter / disconnects shall include a circuit breaker disconnect with a through-the-door interlocking handle (external-mounted starters - sizes 3-120) or a beside-the-door interlocking handle (internal mounted starters - sizes 3-120) spring loaded and designed to rest only in the full ON or OFF state and shall be lockable in these states. A concealed defeater mechanism shall allow entry into the enclosure when the handle is in the ON position. The starter package shall also include:

- Hand-Off-Auto (H-O-A) selector switch
- Two N.O. auxiliary contacts
- Overload heaters
- Manual reset overloads
- 120V control transformer with fusing and secondary grounding

Units with factory-mounted controls shall also include power wiring from the starter control transformer to the secondary control system transformers, and start-stop wiring from the direct digital controller start-stop relay to the starter H-O-A switch.

Combination VFD and Disconnects

A combination VFD/disconnect shall be provided for each fan motor. Each VFD/disconnect shall be properly sized, factory mounted in a full metal enclosure, wired to the fan motor, and commissioned to facilitate temporary heating, cooling, ventilation, and/or timely completion of the project. VFD/disconnects shall include a circuit breaker disconnect with a through-the-door interlocking handle (external-mounted starters - sizes 3-120) or a beside-the-door interlocking handle (internal-mounted starters - sizes 3-120) spring loaded and designed to rest only in the full ON or OFF state and shall be lockable in these states. A concealed defeater mechanism shall allow entry into the enclosure when the handle is in the ON position. The VFD package shall also include:

- Electronic manual speed control
 - Hand-Off-Auto (H-O-A) selector switch
 - Inlet fuses to provide maximum protection against inlet short circuit
- Current limited stall prevention
Auto restart after momentary power loss
Speed search for starting into rotating motor
- Anti-windmill with DC injection before

start

- Phase-to-phase short circuit protection
- Ground fault protection

Units with factory-mounted controls shall include a control transformer with sufficient capacity to support both the VFD and controls requirements, binary output on/off wiring, analog output-speed signal wiring, and all interfacing wiring between the VFD and the direct digital controller. The VFD shall be UL508C listed and CSA certified and conform to applicable NEMA, ICS, NFPA, and IEC standards.

Factory-Mounted Control Options Electronic End Devices

All factory-mounted control devices shall be provided to accommodate integration into existing building systems. Devices provided shall be wired to standard point locations of a unit-mounted direct digital controller or terminal block for a remote controller.

Mixing Section Damper Actuators

Spring return actuators shall be mounted with the outdoor air damper linked as normally closed and the return-air damper linked as normally open.

Airflow Measuring Stations (Special Dampers)

Airflow monitoring stations shall provide a 2 to 10 Vdc signal, which corresponds to cfm, for controlling and documenting airflow.

Temperature Sensors

Unit-mounted temperature sensor material shall be selected for ease of integration into existing BAS control systems.

Fa Discharge Temperature Sensors

A button or probe temperature sensor shall be mounted in the fan discharge. The sensor material shall be selected for ease of BAS integration.

Averaging Temperature Sensors

An averaging temperature sensor shall be serpentine across the functional section. Bends of the capillaries shall be curved and

fastened with capillary clips to prevent crimping and minimize wear. The sensor material shall be selected for ease of BAS integration.

Low-Limit Switches

A double-pole low limit switch shall be wired to a momentary push-button reset circuit. Capillaries are serpentine across the entering side of the coil. The bends of the capillaries shall be curved and fastened with capillary clips to prevent crimping and minimize wear. A separate low limit shall be provided for each coil in a coil stack.

Airflow Switches

A differential pressure switch piped to the discharge and suction sides of the fan shall indicate fan status.

Dirty Filter Switches

A differential pressure switch piped to both sides of the filter shall indicate filter status.

